



# NOTTINGHAM CITY CENTRE URBAN DESIGN GUIDE

May 2009



Nottingham  
City Council

# Massing

## Introduction

The first two sections of this design guide deal with the siting of buildings and the public spaces in between buildings – this section relates to their height. This is a very important issue in Nottingham because the city's skyline is revealed along a ridge between the high points of the Castle Rock and the Lace Market Cliff, from where St Mary's contributes so much to the city's character. However there is development pressure to construct taller buildings ranging in scale from a couple of extra floors on buildings in the heart of the city centre at one end of the spectrum, to proposals for tall towers that would alter forever the city's skyline at the other. This section describes the topography of the city, key views and the current heights of buildings before setting out a strategy for the massing of all new buildings together with a tall buildings strategy for the city centre. This is followed by rules to guide the height of new buildings and the way that they relate to the streets as well as the design of tall buildings.



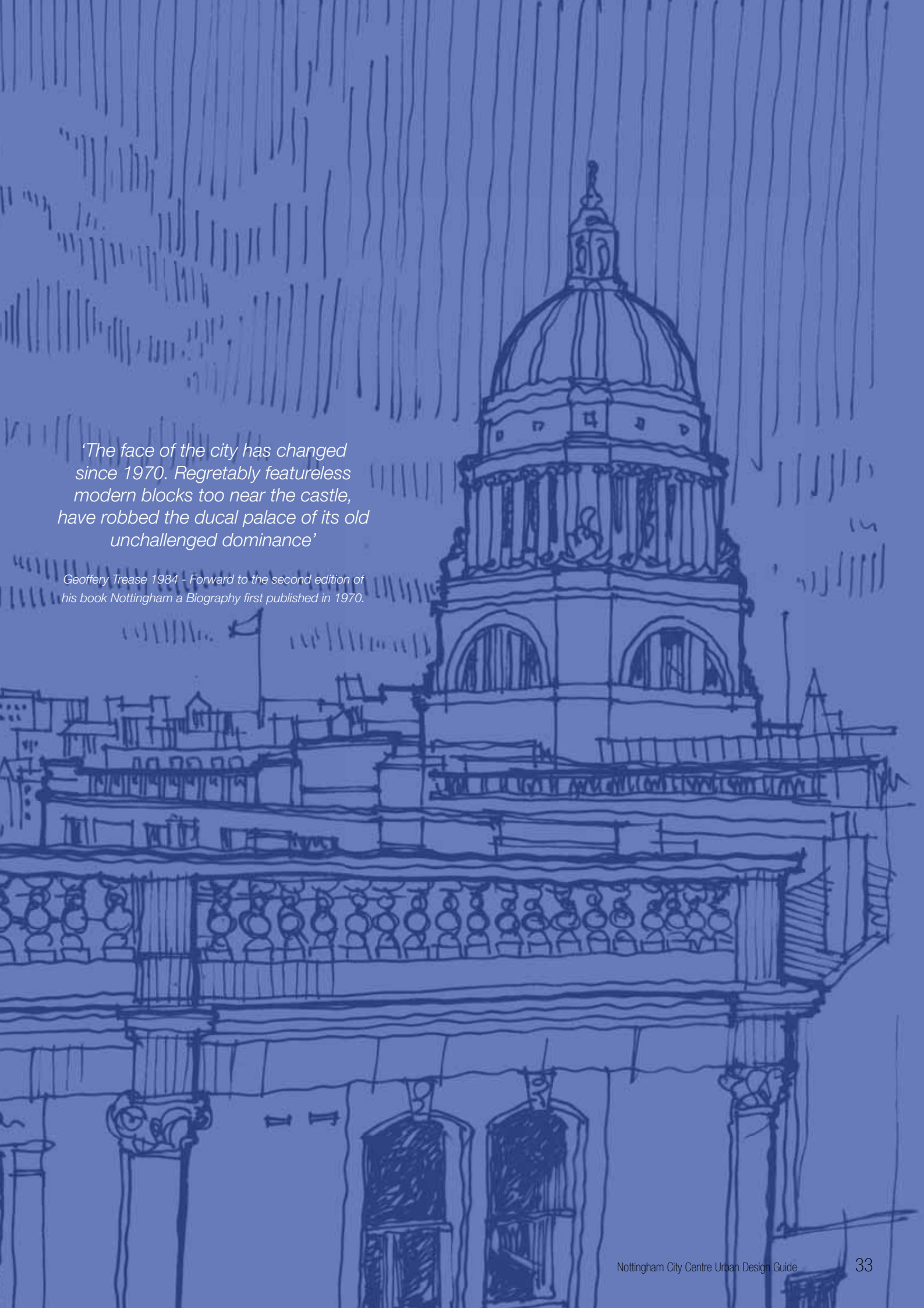

*'The face of the city has changed since 1970. Regretably featureless modern blocks too near the castle, have robbed the ducal palace of its old unchallenged dominance'*

*Geoffery Trease 1984 - Forward to the second edition of his book Nottingham a Biography first published in 1970.*

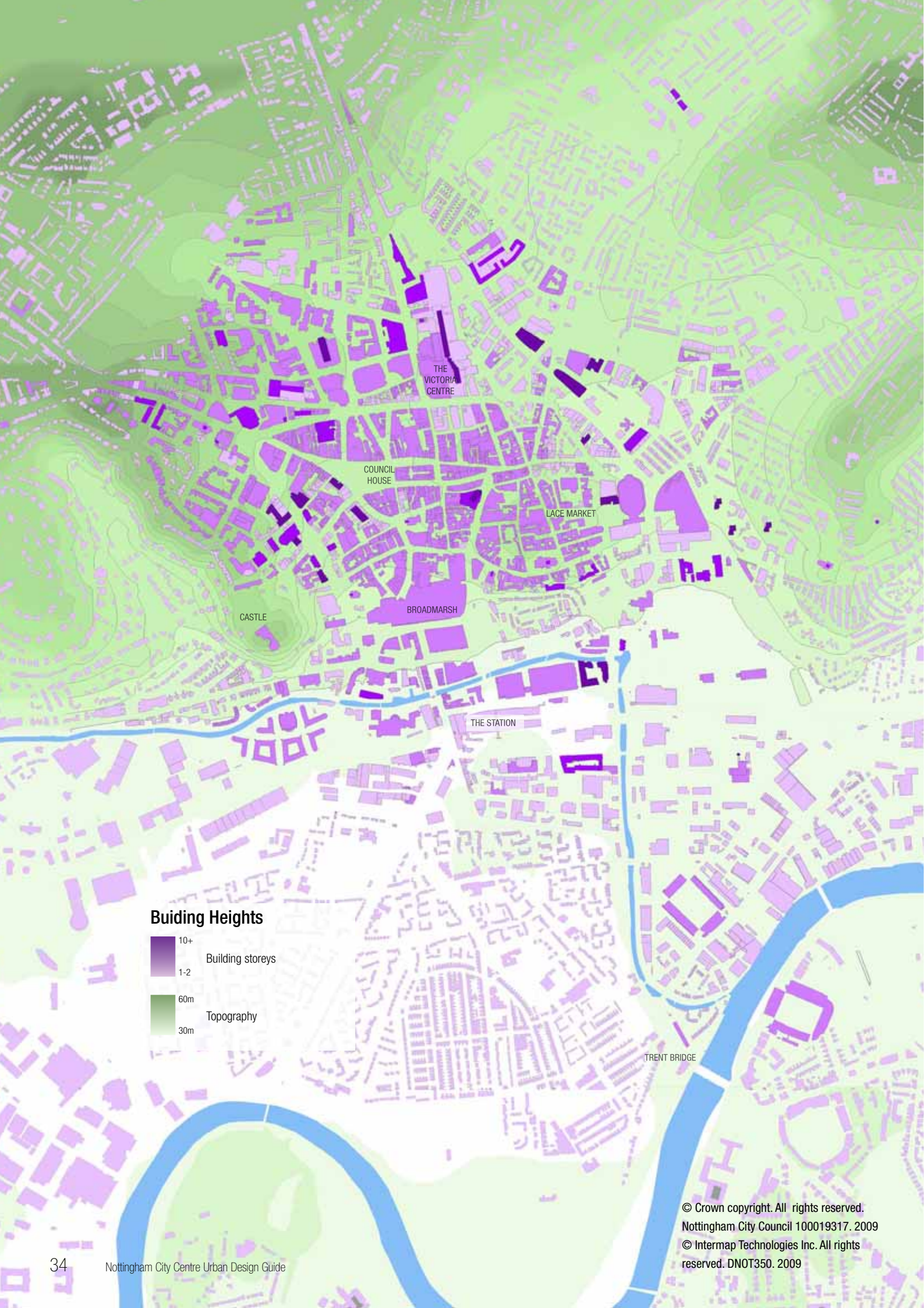

**Building Heights**

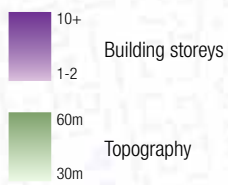

© Crown copyright. All rights reserved.  
 Nottingham City Council 100019317. 2009  
 © Intermap Technologies Inc. All rights reserved. DNOT350. 2009

# Massing

Today

**Nottingham is a medieval city and the predominant character of buildings in the core of the city ranges from three to six storeys. Above this rises Lace Market Cliff, extending to the Park, Castle Rock, the Dome of the Council House and the spires and towers of the city's churches. This character has been damaged by some modern buildings and care needs to be taken to prevent further damage.**

As the engraving on Page 2 illustrates, Nottingham is a city on two hills. Travellers arriving across the flood plain of the River Trent would have seen the city rise up before them on a saddle of land between the two hills punctuated by the the spire of St. Peter's Church. This southern prospect remains a key view of the city for travellers arriving at the station. This archetypal view of Nottingham has been eroded over the years particularly as the dominance of the Council House has been challenged by tall buildings. Nevertheless the two hills remain prominent with stacked warehouses of the Lace Market climbing up to St. Mary's Church forming one of the iconic views of the city centre.

The views of the city centre from the north are quite different. Because the two hills are in fact promontories on a ridge, the city appears much flatter and the taller buildings such as the Victoria Centre flats more prominent.

Buildings in the city centre vary in height from 3 to 6 storeys. Generally the older buildings are smaller with the Victorian and later buildings rising to six storeys. The mix of these buildings on the city centre streets creates a very varied building profile that nevertheless retains a strong unity of character.

This unity of character comes from the consistency of street enclosure ratio in the centre of the city. The main streets tend to have a 1:1 enclosure ratio, meaning that the predominant building height is the same as the width of the street. This ratio increases on secondary streets that are narrower with the same height of buildings and also in the Lace Market where the buildings are taller. The tightest enclosure ratios are in the alleyways which form miniature canyons running through the historic core of the city.

In the regeneration areas there is far less consistency of building height and urban enclosure. The older buildings in these areas tend to be low-rise industrial premises. There are however also a significant numbers of larger structures that dominate the character of the area. The tallest of these is the chimney of the incinerator in Southside which is one of the tallest structures in the city.

Green's Windmill is prominent on the hill to the east of the city centre



Huntingdon Street - Larger buildings are found around the edge of the city centre



The city's skyline is dominated by the Council House



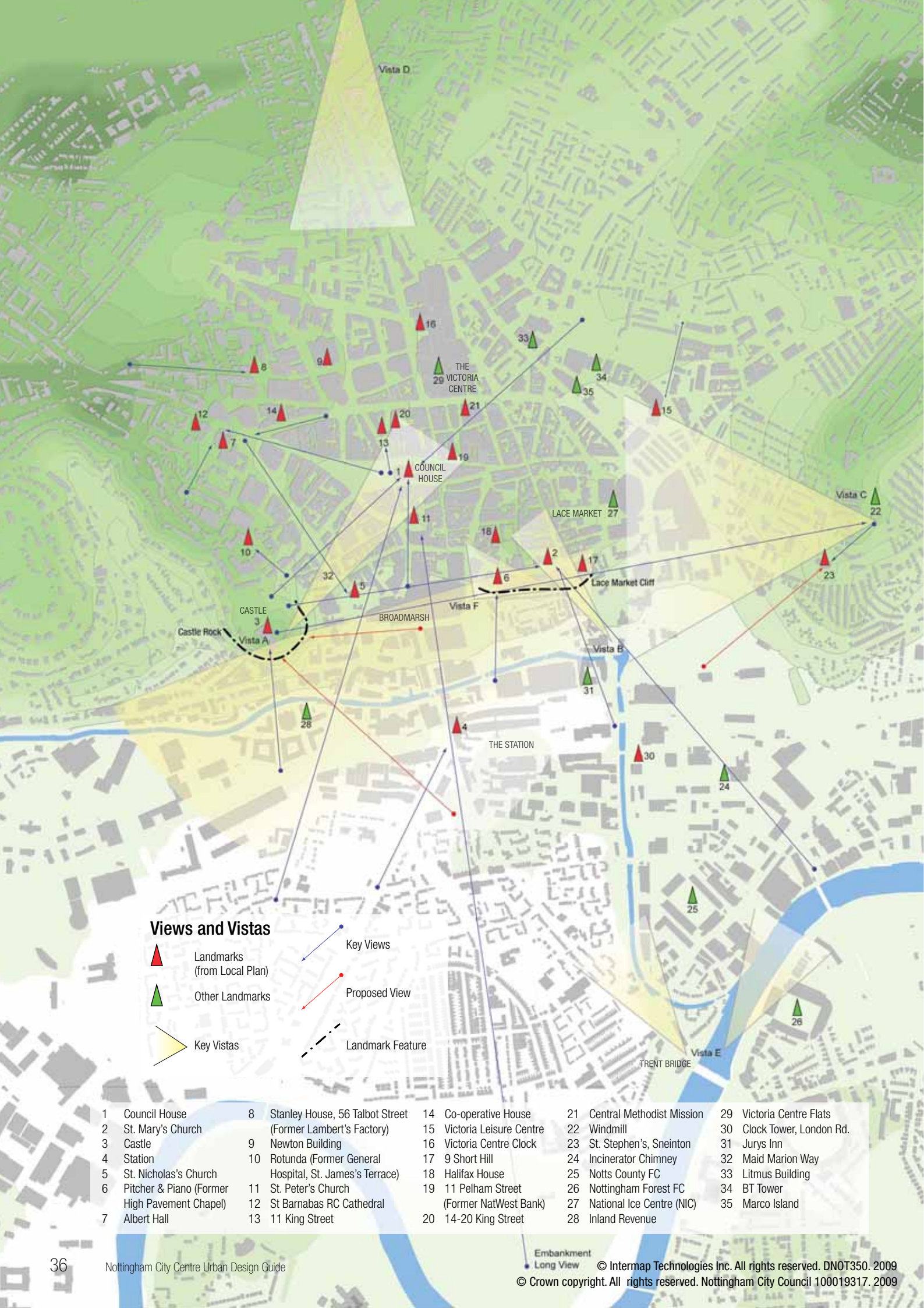

### Views and Vistas

-  Landmarks (from Local Plan)
-  Other Landmarks
-  Key Vistas
-  Key Views
-  Proposed View
-  Landmark Feature

- |   |   |                            |                              |                            |
|---|---|----------------------------|------------------------------|----------------------------|
| 1 Council House                                 | 8 Stanley House, 56 Talbot Street                         | 14 Co-operative House      | 21 Central Methodist Mission | 29 Victoria Centre Flats   |
| 2 St. Mary's Church                             | 9 Newton Building   | 15 Victoria Leisure Centre | 22 Windmill                  | 30 Clock Tower, London Rd. |
| 3 Castle  | 10 Rotunda (Former General Hospital, St. James's Terrace) | 16 Victoria Centre Clock   | 23 St. Stephen's, Sneinton   | 31 Junys Inn               |
| 4 Station                                       | 11 St. Peter's Church                                     | 17 9 Short Hill            | 24 Incinerator Chimney       | 32 Maid Marion Way         |
| 5 St. Nicholas's Church                         | 12 St Barnabas RC Cathedral                               | 18 Halifax House           | 25 Notts County FC           | 33 Litmus Building         |
| 6 Pitcher & Piano (Former High Pavement Chapel) | 13 11 King Street   | 19 11 Pelham Street        | 26 Nottingham Forest FC      | 34 BT Tower                |
| 7 Albert Hall                                   |   | 20 14-20 King Street       | 27 National Ice Centre (NIC) | 35 Marco Island            |

# Massing

## Strategy - Views and Vistas

**An important issue when considering the height of buildings is their effect on views and vistas in the city centre. It is therefore important to identify each of these views.**

The heights of buildings in the city centre are important both in close-up (dealt with on the following page) and long views. The key views and vistas in and around the city centre have been assessed by both the Council and the Civic Society and are summarised on the plan to the left.

**Vistas:** The yellow cones on the plan indicate the main vistas from within the city. These are long views where you get a sense of the form and character of a significant part of the city. These include:

- *The Castle:* There is a good vista from the Castle towards the Council House over the city centre across the Lace Market Cliff to Sneinton Windmill and Colwick Woods beyond. This vista largely misses the taller buildings of Maid Marian Way. The Castle also affords a panoramic vista over the plain of the River Trent (Vista A).

- *From the South:* There are a few locations from the south where the profile of the city can be seen. These include a vista of the Castle from Queens Drive. Long vistas from Trent Bridge (Vista E), Lady Bay Bridge and the iconic prospect of the Lace Market from the top of London Road (Vista B).

- *From the North and East:* The key views are from the Belle Vue Reservoir in the north and Windmill Hill in the east. In these vistas the impact of the Victoria Centre is particularly noticeable and the traditional buildings of the city are largely overwhelmed by more recent large structures. Views of the Windmill are important from parts of Eastside, and a Key View is identified from the proposed park on the Island Site.

**Views:** In addition to these vistas there are a series of specific views in the city centre shown as blue arrows on the plan to the left. These are generally views along a street or framed between buildings towards one of the landmarks in the city that are also shown on the plan. It is important that these views are not blocked. However it is just as important that taller structures do not intrude into the background of these views.

Developers will be expected to use the 3D computer model of Nottingham city centre commissioned from Zmapping, to illustrate and assess the impact of their developments on the key views and vistas.



Vista B - Towards St. Mary's Church from London Road



Vista A - From the Castle



Vista F - Towards Lace Market Cliff

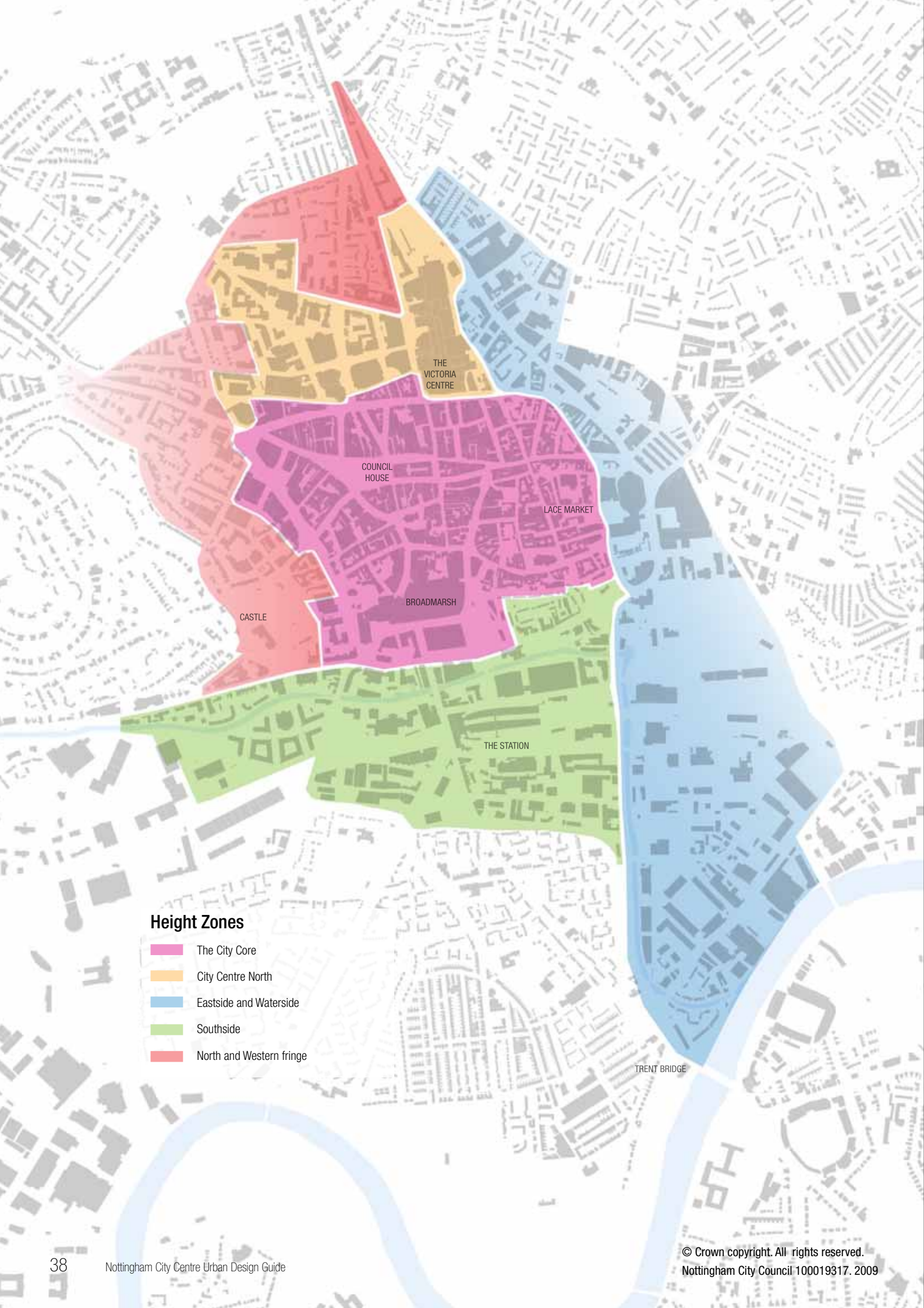

### Height Zones

- The City Core
- City Centre North
- Eastside and Waterside
- Southside
- North and Western fringe



# Massing

## Strategy - Building Heights

**The predominant heights of buildings in the city centre are based on the heights of existing buildings, particularly in the historic areas, and the impact of new buildings in the regeneration areas.**

**Building Height:** In the heart of the city the aim is to respect the current massing and character of the existing historic buildings. This relates partly to the total height of the buildings but also to the impact of this height on the enclosure ratios of streets. The plan to the left indicates a series of massing zones including:

- *The City Core:* This is the most critical area in terms of its character and also its impact on many of the views and vistas. The height of new buildings in this area will be mainly determined by their immediate context. However it is not expected that this will exceed 5 residential storeys or equivalent over an active ground floor. There is an existing cluster of taller buildings on Maid Marian Way which impact on many of the views in the city core particularly from the Castle towards the Old Market Square. There should be no further tall buildings in this area and if existing tall buildings are to be redeveloped their visual impact should be reduced.
- *City Centre North:* This area includes a number of taller structures including Nottingham Trent University and the Victoria Centre. It is also less prominent in most of the views so that slightly taller buildings would be appropriate – ground plus up to 7 residential storeys or equivalent.

- *Eastside:* The area runs down the eastern side of the city centre from the rear of the Victoria Centre through Sneinton Market to the Island Site. It borders St Anns and Sneinton so that whilst the predominant building height is identified as ground plus 6 residential storeys or equivalent, this should be reduced by 2 storeys along the fringes of these residential areas. Included within Eastside is the proposed tall building zone (see next page).
- *Waterside:* Comprises the area south of the railway and east of London Road canal frontage, running down to the River Trent. Predominant height is proposed as ground plus 6 residential storeys or equivalent, dropping down by 2 storeys in the vicinity of Turney's Quay.
- *Southside:* South of the city core, a lower scale of ground plus 4 residential storeys is envisaged because of its more sensitive location with respect to longer views and its position adjacent to the Meadows residential area. However, there may be opportunities within this zone for elements of taller buildings outside the Station conservation area but in the vicinity of the Station Hub, recognising the approved schemes at Sovereign House and Meadows Gateway.
- *North and western fringes:* This is a sensitive area around the Castle with a strong historic character. It is envisaged that the predominant height will be ground plus four residential storeys or equivalent.

These predominant storey heights respect the character of each of these areas. However, part of the character of Nottingham is a variation in height. The massing rules therefore allow for occasions where a landmark feature exceeds these heights. The variation of heights within the limits set above is also encouraged. Generally these heights will allow buildings to fit with the street sections illustrated on Page 42. However where these heights will cause the street section to exceed the illustrated enclosure ratios, set backs at upper floors on the building frontage should be used to reduce the impact.

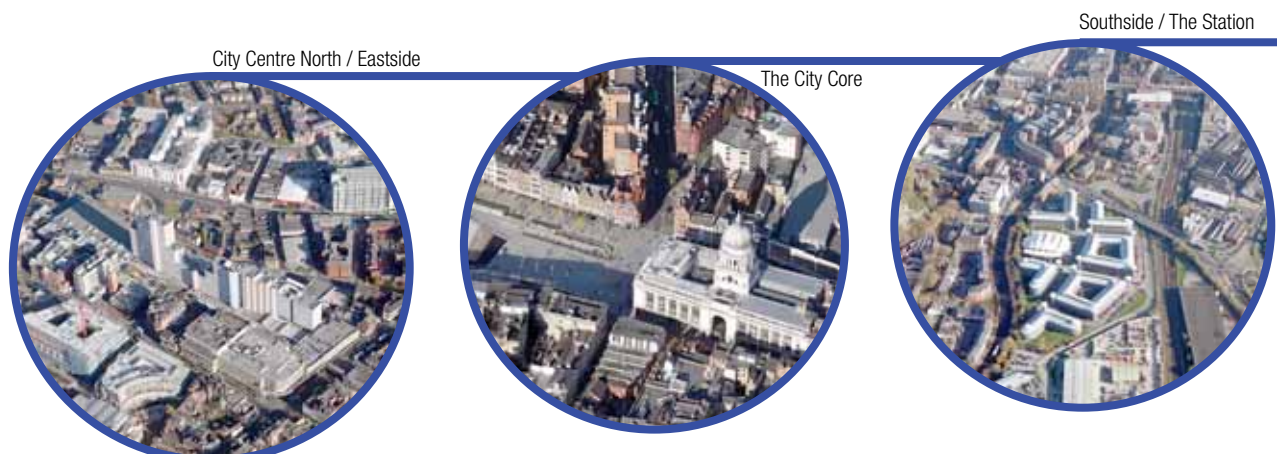

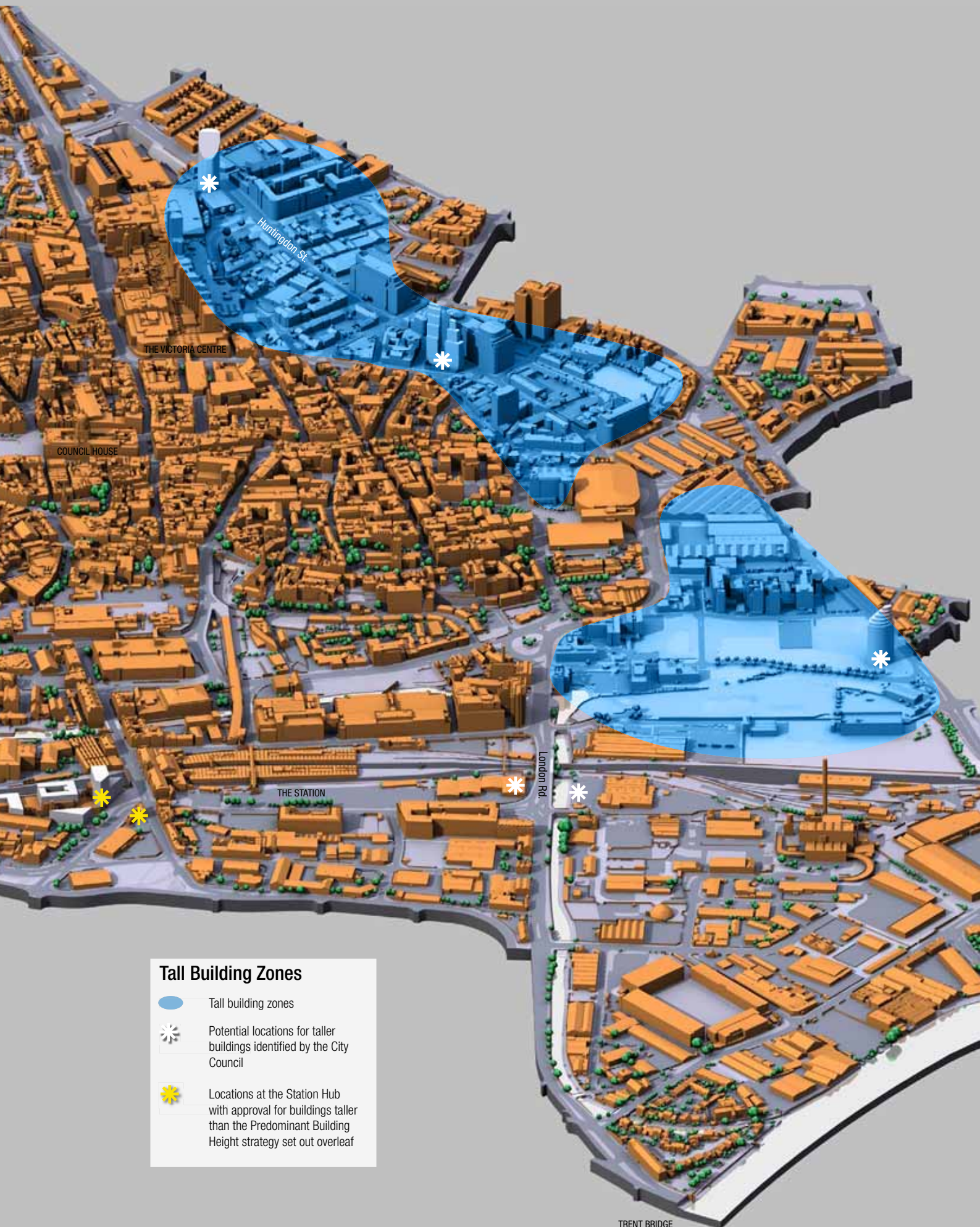

**Tall Building Zones**

- Tall building zones
- ✱ Potential locations for taller buildings identified by the City Council
- ✱ Locations at the Station Hub with approval for buildings taller than the Predominant Building Height strategy set out overleaf

# Massing

## Strategy - Tall Buildings

**There is a need for a strategy to regulate the location of tall buildings in the city centre. In recent years there have been a number of proposals to develop tall buildings and it is important that a strategy is put in place to control their location and design.**

There are broadly two approaches to tall buildings. The first is to celebrate them by locating towers to emphasise the topography of the city as Sheffield and Newcastle have done. The other approach is to locate them where they will not impinge on key views or the setting of historic buildings as Bristol has done. It is clear from the analysis of Nottingham's character and the consultations that have been done, that the latter approach should be pursued in Nottingham.

Tall buildings in this strategy include any building that exceeds the predominant building heights set out on the previous page. All buildings that do this should be subject to a tall building assessment based on the views and vistas described earlier in this section. Provided that the results of this assessment are acceptable, it is possible that modest tall buildings 3-4 storeys above the predominant height could be acceptable across the city centre provided that they are designed as landmarks. There are some locations close to the Station Hub where buildings taller than the Predominant Building Height anticipated by the Urban Design Guide for Southside may be appropriate, subject to a tall building assessment. Sovereign House and Meadows Gateway identified on the plan on page 40, are approved schemes for taller buildings in this area.

Apart from the exceptions by the station a series of potential tall building zones have been explored in the city centre. These have included the possibility of adding to the cluster of medium height buildings on Maid Marian Way and creating a cluster of taller buildings along the River Trent. Both were ruled out because the buildings would have dominated key views in the city, particularly those from the Castle and, in the case of Maid Marian Way, from Old Market Square.

The strategy therefore identifies a tall building zone on the eastern side of the city centre. This runs from the Victoria Centre southwards to the railway line but excludes Sneinton Market. This is the least visible part of the city centre in the views analysis largely because of the taller buildings that already exist in the area. The City Centre Masterplan also identifies two potential tall building sites in this area.

The extent of this tall buildings zone is indicated on the model to the left. Tall buildings in this area will grow out of the predominant building height described on the previous page. They will still need to be subject to a tall building assessment and it should not be assumed that all tall building proposals in this area will be acceptable. It is anticipated that most tall buildings will not exceed 25 or at the most 30 storeys however there may be scope to justify a taller structure in this area provided that it is of exceptional design quality. All tall buildings should be designed as landmark towers, taking particular care to avoid creating a visual barrier between the city and the communities to the east. They will not be allowed directly adjacent to the residential areas of St. Anns and Sneinton.

The views below illustrate the way in which the 3D model of the city centre can be used to assess the impact of a tall building - in this case the tower on Huntingdon Street proposed in the City Centre Masterplan.



The tower is not visible in Vista F of St. Mary's Church



It forms a prominent landmark in the view down Huntingdon Street

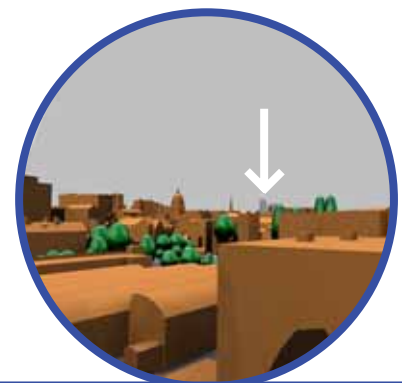

The impact on the skyline in Vista A from the Castle is minimal

# Massing

## Rules

**3.1 Predominant building heights:** The maximum heights of all new buildings should correspond to the maximum heights set out in the six zones described on the previous page. These maximum heights relate to the predominant eaves height of the buildings and are expressed in numbers of residential storeys over active ground floor uses. This is measured from the predominant public realm level and for this purpose residential floor to floor storey heights are assumed to be 3m and active use floor to floor heights are assumed to be 5m. These rules do not override consideration of the building's context especially in conservation areas and schemes affecting the setting of listed buildings.

*Justification: To ensure that the character of the different parts of the city are preserved.*

**3.2 Street enclosure ratios:** The height of buildings onto key streets may need to be reduced to preserve the street enclosure ratio as set out below. This can be achieved by setting-back upper floors so that they are not visible from the street. Where new streets are being created in the regeneration areas, they should respect these enclosure ratios.

- Arterial routes 1:2
- The Ring Road 1:1.5
- High Streets 1:1
- Secondary Streets 1:0.75
- Minor Streets 1:0.75
- Alleyways 1:0.5

*Justification: To ensure that the maximum heights of buildings do not overwhelm the character of key streets.*

Height Zone	Max. no. of residential storeys over active ground floor	Max. no. of commercial storeys over active ground floor	Max. eaves height from predominant ground level
The City Core	Ground + 5	Ground + 4	20m
The City Centre North	Ground + 7	Ground + 5	26m
Eastside	Ground + 6	Ground + 5	23m
Waterside	Ground + 6	Ground + 5	23m
Southside	Ground + 4/5	Ground + 4	20m
Northern and Western fringes	Ground + 4	Ground + 3	17m



Nottingham Skyline 2005 - © Martine Hamilton Knight

**Enclosure ratio** – This is a measure of the profile of the street. It relates the height of the buildings to the width of the street (expressed in this guide with the height of the building first). In a street with a 1:1 enclosure ratio (such as Lister Gate), the height of the buildings is the same as the width of the street. If the enclosure ratio is 1:2 (for example Mansfield Road), the height of the buildings is half the width of the street. An enclosure ratio of 1:0.5 (for example Kings Walk), means that the buildings are twice as high as the width of the street.

**Arterial Route 1:2**



Mansfield Road

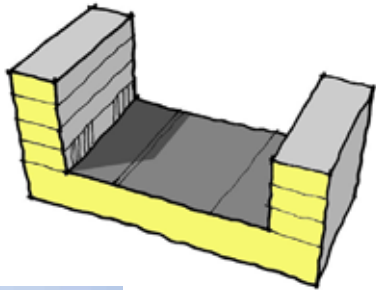

**The Ring Road 1:1.5**



Lower Parliament Street

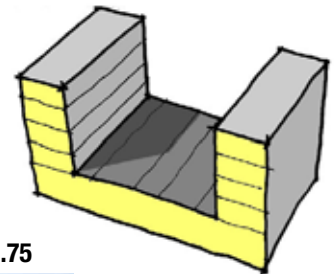

**High Streets 1:1**



Lister Gate

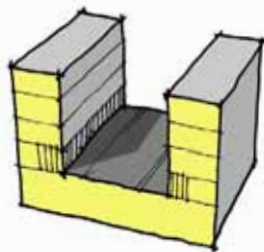

**Secondary Streets 1:0.75**



Queen Street

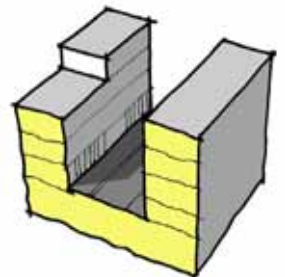

**Minor Streets 1:0.75**



St. Marys Gate

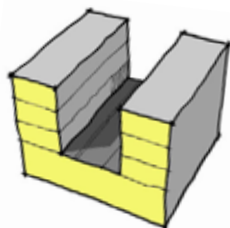

**Alleyways 1:0.5**



Kings Walk



# Massing

## Rules

## Continued

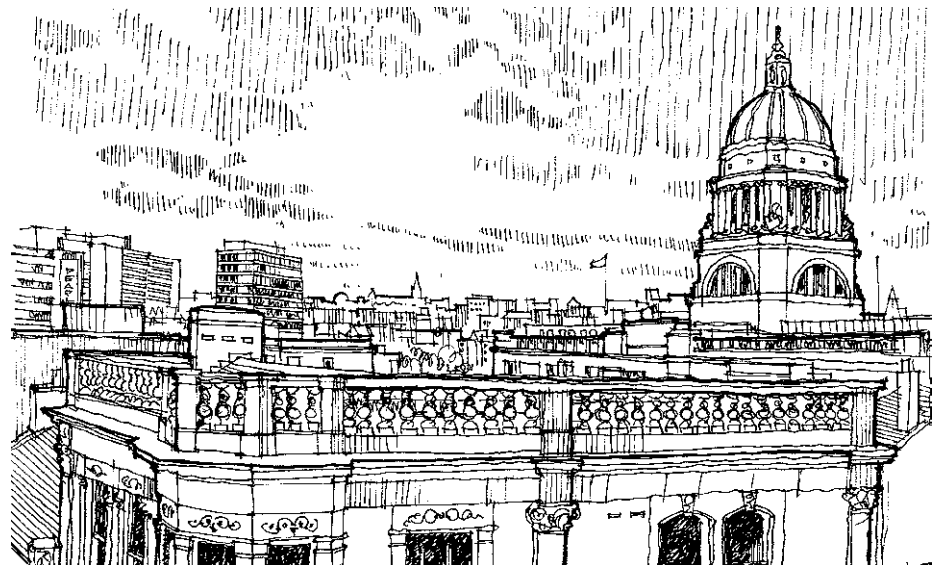

View of the Council House Dome

**3.3 Variations in height:** An important part of Nottingham's character is the varied roof line created by buildings of differing heights. This should be replicated in new buildings.

*Justification: Because large monolithic buildings are intrusive and out of character with the city.*

**3.4 Landmarks:** Heights may rise above the maximum heights set out above for the purpose of marking corners or terminating important vistas. These landmarks should be vertical features with a small footprint and should not rise more than 2 residential storeys (or equivalent).

*Justification: Because buildings traditionally respond to their location to create local landmarks which add to the richness of the city centre.*

**3.5 Plant Rooms:** These maximum heights are exclusive of plant and other equipment such as lift motors and antenna. These should however be designed so that they are not visible from the surrounding streets nor prominent in long views of the scheme.

*Justification: While there is a practical requirement to accommodate plant rooms these can become intrusive visual features.*

**3.6 The fifth elevation:** Care should be taken with the design of the roofs of buildings. These should be designed to be attractive when viewed from above with plant and equipment enclosed and designed as part of the building. Green roofs are encouraged as a contribution to the ecology of the city and also where possible as an amenity for occupants of the building.

*Justification: Due to the topography of the city, the roofs of many buildings will be visible from the Castle and the Lace Market as well as tall buildings. Green roofs contribute to the ecological diversity of the city as well as the attractiveness of buildings.*



**3.7 Tall Building definition:** Tall buildings are defined as all buildings that rise above the maximum building heights set out in 3.1. Subject to a satisfactory tall building assessment buildings that are no more than 4 storeys over the predominant height may be acceptable in appropriate locations.

*Justification: Provided that they do not impact negatively on key views or the character of an area, and provided that they are designed as slender structures, taller buildings can be beneficial.*

**3.8 Tall Building Zone:** Buildings more than 4 storeys over the predominant height will only be acceptable in the tall building zone designated on the previous page or in the locations identified next to the station.

*Justification: The visual impact of taller structures is only acceptable within these zones.*

**3.9 Tall building assessment:** All tall buildings will be subject to a tall building assessment as set out in the CABE, English Heritage Guidance on Tall Buildings. This will include a view analysis to show the impact of the building on all of the views identified on Page 36 together with key local views to be agreed in advance with the Council. In addition this will include the need for an Environmental Impact Assessment of the proposal.

*Justification: The tall building assessment is important to ensure that the visual impact of tall buildings is fully understood as part of the planning process.*

**3.10 The design of tall buildings:** The quality of the design of tall buildings is fundamental to the principle of whether the building is acceptable. Outline applications will not therefore be accepted for tall buildings. The design of tall buildings should pay particular attention to the base and top of the building and should use the CABE, English Heritage Guidance as a check list.

*Justification: Because of the visibility of tall buildings they need to be of exceptional design quality so that the architecture is central to the principle of their acceptability.*

**Massing:** The scale, form, proportion and silhouette of the building should create a slender tower.

**The top of the building:** The design of the top of the building is critical and should be designed as an integral part of the building.

**Contribution to the public realm:** Tall buildings should not be designed as objects in space. They, or their podium should respect the building line and they should include active ground floor uses.

**Microclimate effects:** Tall buildings applications will be accompanied by wind and shading assessments.

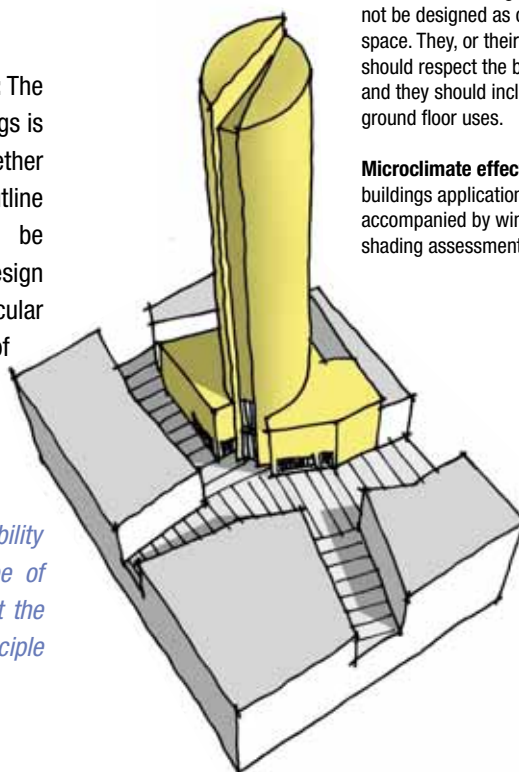

*'The centre has been cleaned up but not, as in some cities, depersonalised. Even in Childhood I was aware of the brash self-confidence in Nottingham, though perhaps the less conscious you are of it the more certain you may be to acquire it'*

*Alan Sillitoe writing about Nottinghamshire in 1987*







# Activity

## Introduction

**The most beautiful city in the world is nothing if its streets don't throng with life and its buildings glow with activity. The activity in a city is therefore at least as important as its design. This relates to the mix of different uses that bring people into the city centre at different times of the day. It relates to the intensity of activity and the density of office and residential uses that determines how many people there are about. It also relates to the design of buildings and the extent to which they animate the surrounding streets as well as the design of those streets and the way that they encourage vitality.**

**In this section we look at the level of activity in Nottingham City Centre today and set out a strategy for preserving and enhancing the activity of the city centre in the future. This leads onto a set of rules that new buildings need to follow to ensure that they contribute to the vitality of the city centre.**

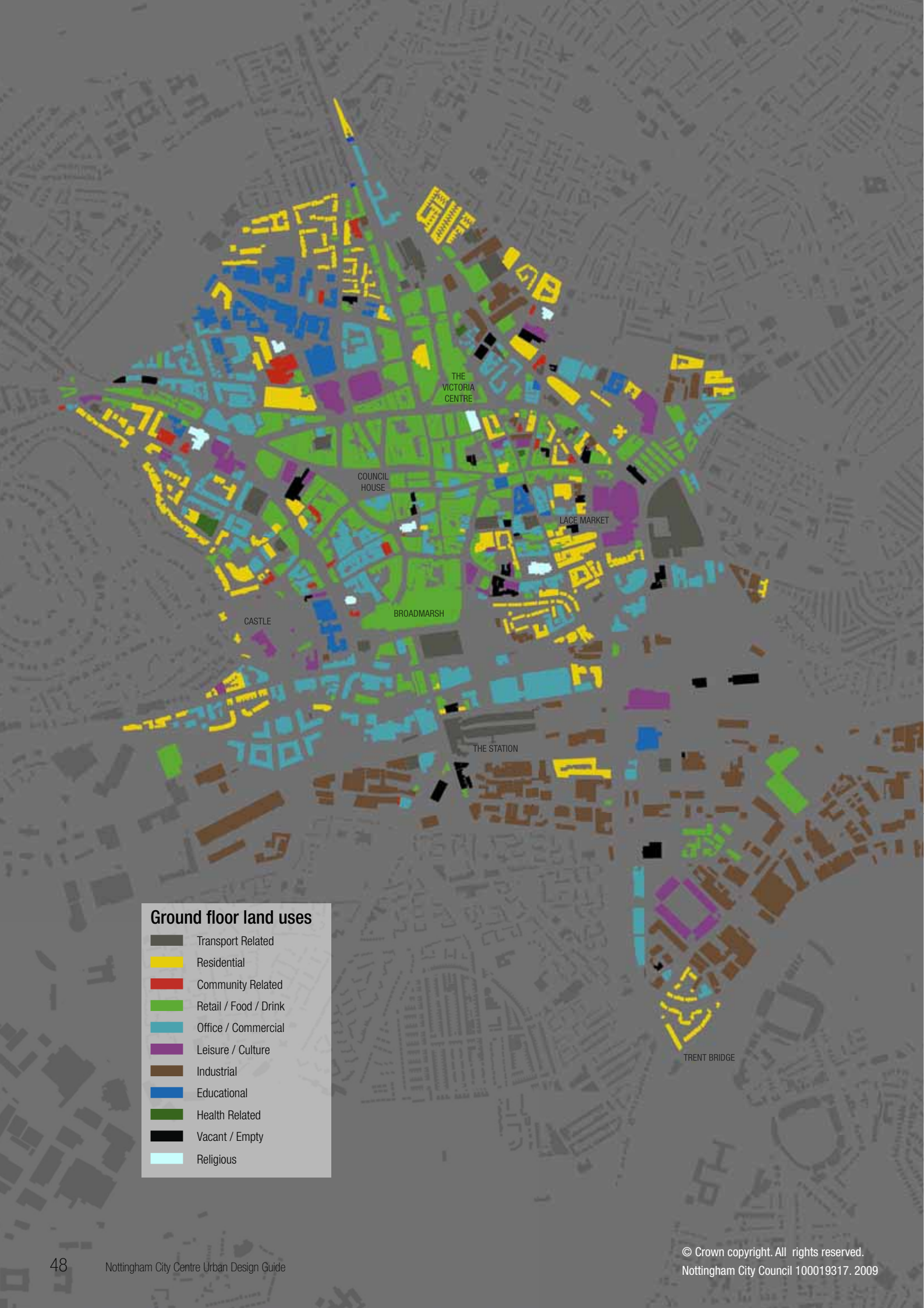

**Ground floor land uses**

- Transport Related
- Residential
- Community Related
- Retail / Food / Drink
- Office / Commercial
- Leisure / Culture
- Industrial
- Educational
- Health Related
- Vacant / Empty
- Religious

# Activity

## Today

**The activity in the city centre is based on the mix of uses that has developed in recent years and the density of development. Parts of the city centre have become very lively in recent years but activity falls off very quickly in the areas on the edge of the city centre.**

Nottingham city centre is by any standard a lively, bustling place that draws people from throughout the region to shop, work, socialise, learn, access services, worship etc. From further a field the city draws tourists and is also increasingly becoming a place that people call home. All of this has happened in a remarkably compact city centre and has contributed to the life of the city and to the huge increase in footfall that has taken place in the last decade.

In the past, UK city centres were notorious for closing down at 6pm and becoming ghost towns. This was because they were dominated by shops and offices which closed at this time. At ground floor level at least, the city centre remains dominated by retailing. However, increasingly the upper floors have seen an expansion of office space, residential development and hotels that have brought far more people into the centre. The evening economy has also expanded rapidly particularly in the northern and eastern parts of the centre as well as in emerging entertainment areas on the canal. Residential development has boomed and the city centre will soon be home to more than 12,000 people. Nottingham Trent University in the northern part of the city

also generates significant activity. The most mixed-use areas are the Lace Market and the areas to the west of the city centre.

The extent to which this mix of uses spills out onto activity on the street is illustrated on the day-time and night-time plans below. These show the changing patterns of activity throughout the city centre. The night time plan is notable for the shadowing effect of the two shopping centres that create quiet areas when they close their doors in the evening.

Traditionally there should be a density gradient running from the highest densities in the centre of the city out to lower densities in the surrounding areas and suburbs. This division was always more stark in Nottingham which was unable to expand beyond the confines of the old city for much of its history so that very high densities could be found right next to open meadows in the area by the railway station. This pattern remains today with densities falling rapidly in the regeneration areas, not because of the meadows but because of vacant and underdeveloped sites. These are the areas with the greatest potential to increase the density of activity around the centre.

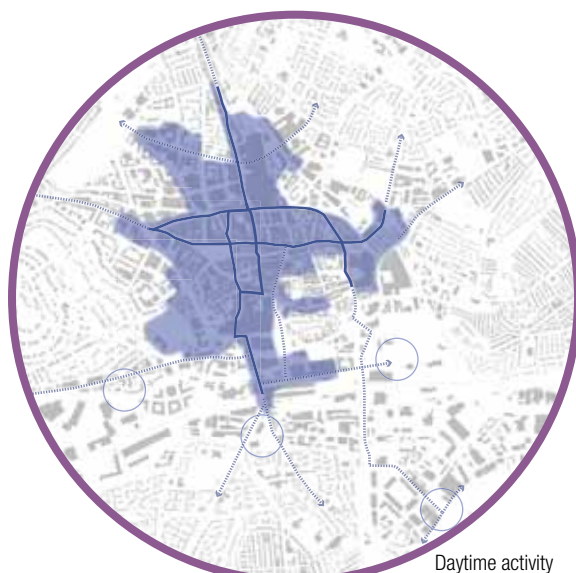

Daytime activity



Evening Activity

- |                               |                               |
|-------------------------------|-------------------------------|
| Existing daytime movement     | Existing evening movement     |
| Extended daytime movement     | Extended evening movement     |
| Daytime activity zones        | Evening activity zones        |
| Potential activity generators | Potential activity generators |

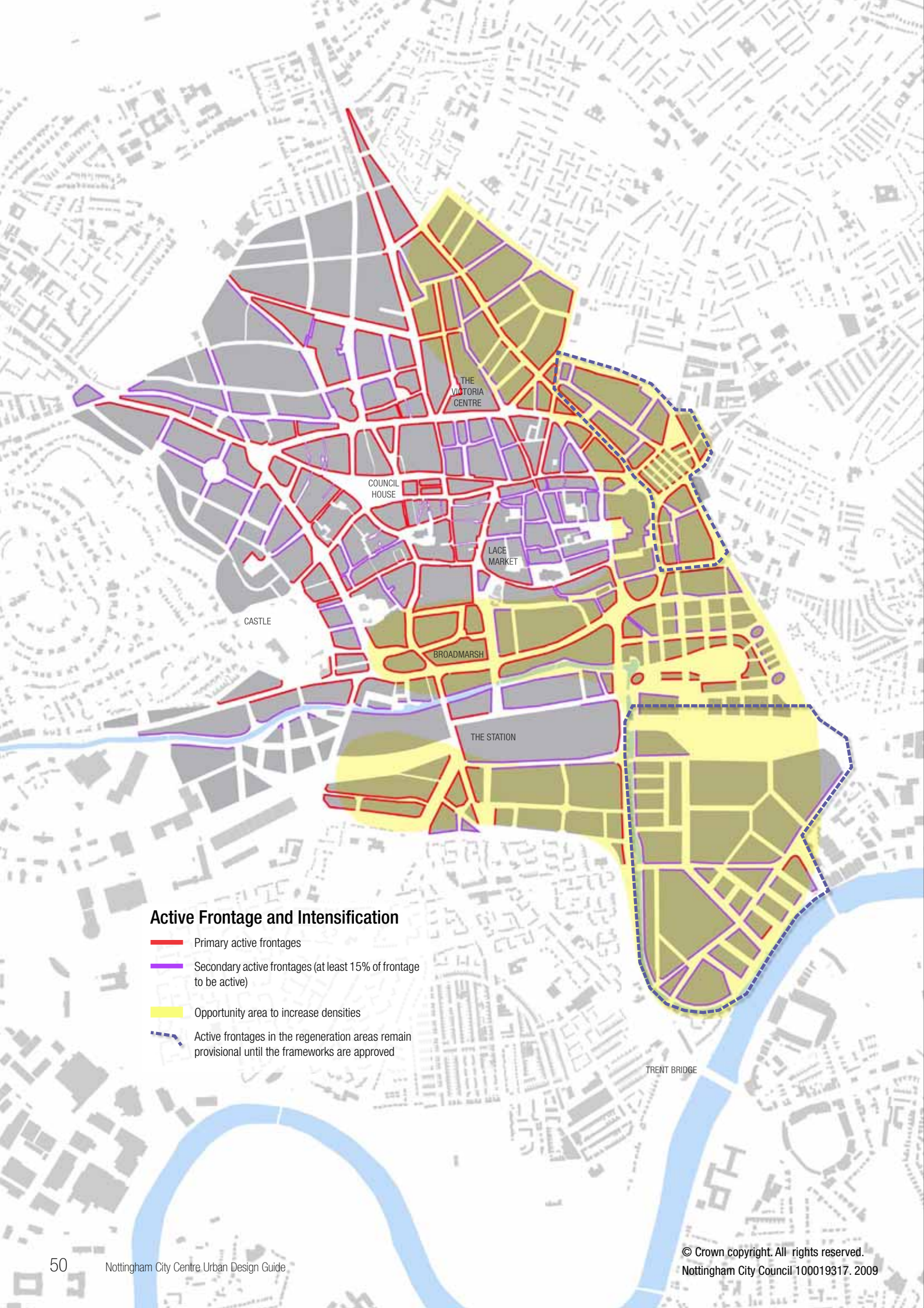

### Active Frontage and Intensification

- Primary active frontages
- Secondary active frontages (at least 15% of frontage to be active)
- Opportunity area to increase densities
- Active frontages in the regeneration areas remain provisional until the frameworks are approved

# Activity

## Strategy

**The strategy to maintain and increase activity in the city centre is based on three strands; increasing the density of development around the fringes of the city centre, promoting a greater mix of uses and ensuring that buildings spill their activity out onto the street.**

**Density and a mix of use:** The strategy for the city centre is to expand the mix of uses throughout the centre. There are no proposals to zone the centre into different uses or functional quarters. As a principle the greater the mix of uses, the more active the city will become, including where appropriate, larger units suitable for families, subject to care being taken to avoid conflicts between residential accommodation and evening uses.

In a similar way, the aim of the City Centre Masterplan is to increase the density of activity in the city centre. This however will be restricted in the core of the city by the limited scope for new buildings and the character of the conservation areas that will restrain building heights as set out in the previous section. The main opportunity to increase densities lies in the regeneration areas to the south and east of the city centre as indicated on the plan to the left. The massing guidelines for these areas provide scope for a considerable increase in density as illustrated by the Island site scheme.

**Active frontages:** It is important that buildings present active frontages to the public spaces of the city as far as possible. By active frontages we mean ground floor shop windows or transparent frontages so that the activity within the building is visible from the street. Ideally this should also include opportunities for activity to spill out onto pavements through street cafes and shop displays. These active frontages should ideally relate to ground floor retail spaces,

cafes, restaurants and bars. However they can also include hotel public facilities, office receptions, galleries and public facilities. These should, where possible, be included in the ground floor of residential and office development in the city centre.

The level of active frontage should be related to the importance of the street. High streets within the centre should be active along their frontage. Similarly arterial routes should contain a significant proportion of active frontage. Secondary streets within the city centre will have less active frontage and minor streets will be active only rarely. However there is a tradition of active frontage on alleys in the city centre that should be continued. The plan to the left shows primary active frontages where at least 75% of the frontage is to be active and secondary active frontage where at least 15% of the frontage is to be active. A mix of housing accommodation types and sizes can help reinforce casual surveillance, with family occupation and front gardens helping to create streets that are more overlooked, and are safer, friendlier places.

Elsewhere on quieter streets and outside the city centre commercial activity is unlikely to be viable. However even here care should be taken to ensure that residential and commercial accommodation relates to the street and provides surveillance without compromising privacy. This is typically done by raising the ground floor accommodation half a metre above the level of the pavement and providing railings along the pavement.

**Community Safety:** Designers will be expected to have fully considered and sought to minimise the crime, disorder and anti-social behaviour implications in proposals. These should include promoting public safety and suitable access for emergency services.



Canalside



Parliament Street



Chapel Bar

# Activity

## Rules



**4.1 Mix of uses:** Buildings in the core of the city and on arterial routes should where possible include a vertical mix of uses. This should include offices, residential accommodation or hotel space on the upper floors and public uses on the ground floor.

*Justification:* Mixed-use buildings generate greater levels of activity throughout the day and therefore add to the vitality of the city.

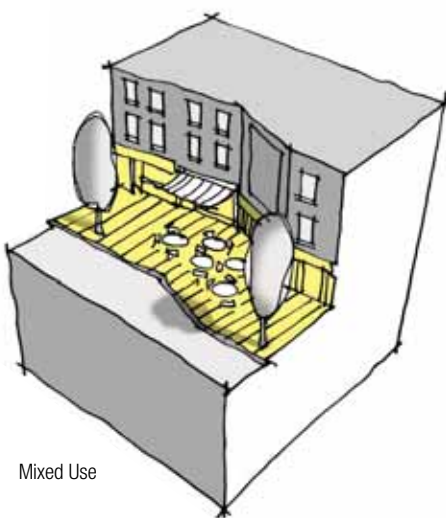

Mixed Use

**4.2 Primary Active Frontage:** Buildings including primary frontages indicated on the plan on the previous page should include active frontages at ground floor level. At least 75% of these frontages should be active by which we mean shop units, cafes or restaurants, offices, public uses and foyers with large areas of glazing.

*Justification:* Active frontages are part of the character of important streets and ensure that the life of the building helps animate the street making it feel safer and more welcoming.

**4.3 Secondary Active Frontages:** The secondary frontages indicated on the plan on the previous page should include at least 15% of active uses, to include corner shops, cafes, foyers and live/work space. Where these uses are not currently viable provision should be made for their introduction in the future.

*Justification:* While active uses may not currently be viable in these spaces at the present time, they should be allowed to emerge as lively urban streets in the future.

**4.4 Building orientation:** All buildings should face onto the street and take their main access from it. It is not acceptable to access office or residential accommodation solely from car parking at the rear or in the basement.

*Justification:* There has been a tendency recently to access buildings from the parking area to the rear of the block. This means that the building turns its back on the street.

**4.5 Eyes onto the street:** New buildings should not present blank facades to the street. All elevations fronting onto streets and public spaces should include windows on the ground and upper floors.

*Justification:* 'Secured by Design' guidelines stress the need for public spaces to be overlooked so that streets feel safer and anti-social activity is deterred.

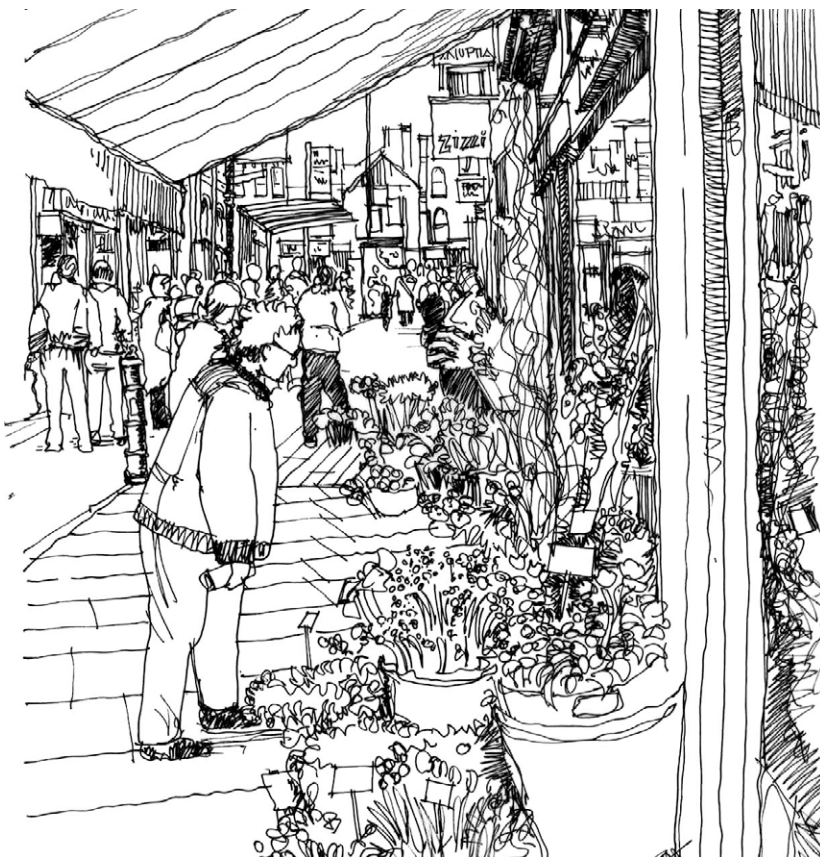

King Street

**4.6 Building-street transition:** Care should be taken in the design of the transition between buildings and the street to provide protection for ground floor residential accommodation where there is no active frontage. This might include elevating the ground floor, using a buffer wall or railings and using a change in levels. Care should however be taken to allow disabled access.

*Justification: There is a need to allow buildings to relate to the street while maintaining the privacy of ground floor accommodation.*

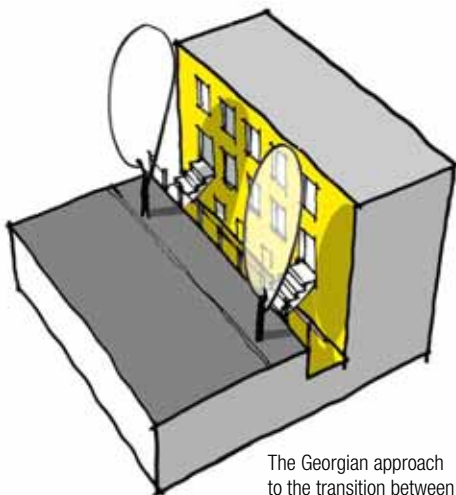

The Georgian approach to the transition between building and street

**4.7 Street activity:** Ground floor uses should where possible include opportunities for street cafes or shop displays to spill out onto the pavement. In larger spaces provision should also be made for public performance.

*Justification: Street cafes and street displays add to the visual interest, diversity and activity of public areas.*

**4.8 Densities:** New residential development in the city centre and the regeneration areas should be built to create dense urban neighbourhoods. High-density residential and office development can be positive. However it will only be appropriate where acceptable levels of amenity can be achieved for the occupants and where the massing, public realm and sustainability guidance set out in this guide can be met.

*Justification: Some recent schemes in the city have been built at densities that have compromised the amenity of occupants and the quality of the public realm. The desire to increase densities on the periphery of the city centre must therefore be tempered by these considerations.*

**4.9 Residential amenity:** The density of residential accommodation is subject to an acceptable level of residential amenity being achieved. It is expected that all living room and bedroom windows will achieve a 15m privacy distance together with the sky view factor described in the sustainability section. Single-aspect flats facing within 30° of due north are unlikely to be acceptable.

*Justification: To ensure an acceptable level of residential amenity in the city centre, 15m is a privacy distance commonly used in other UK city centres. Apartments facing within 30° of due north are unlikely to get any direct sunlight.*



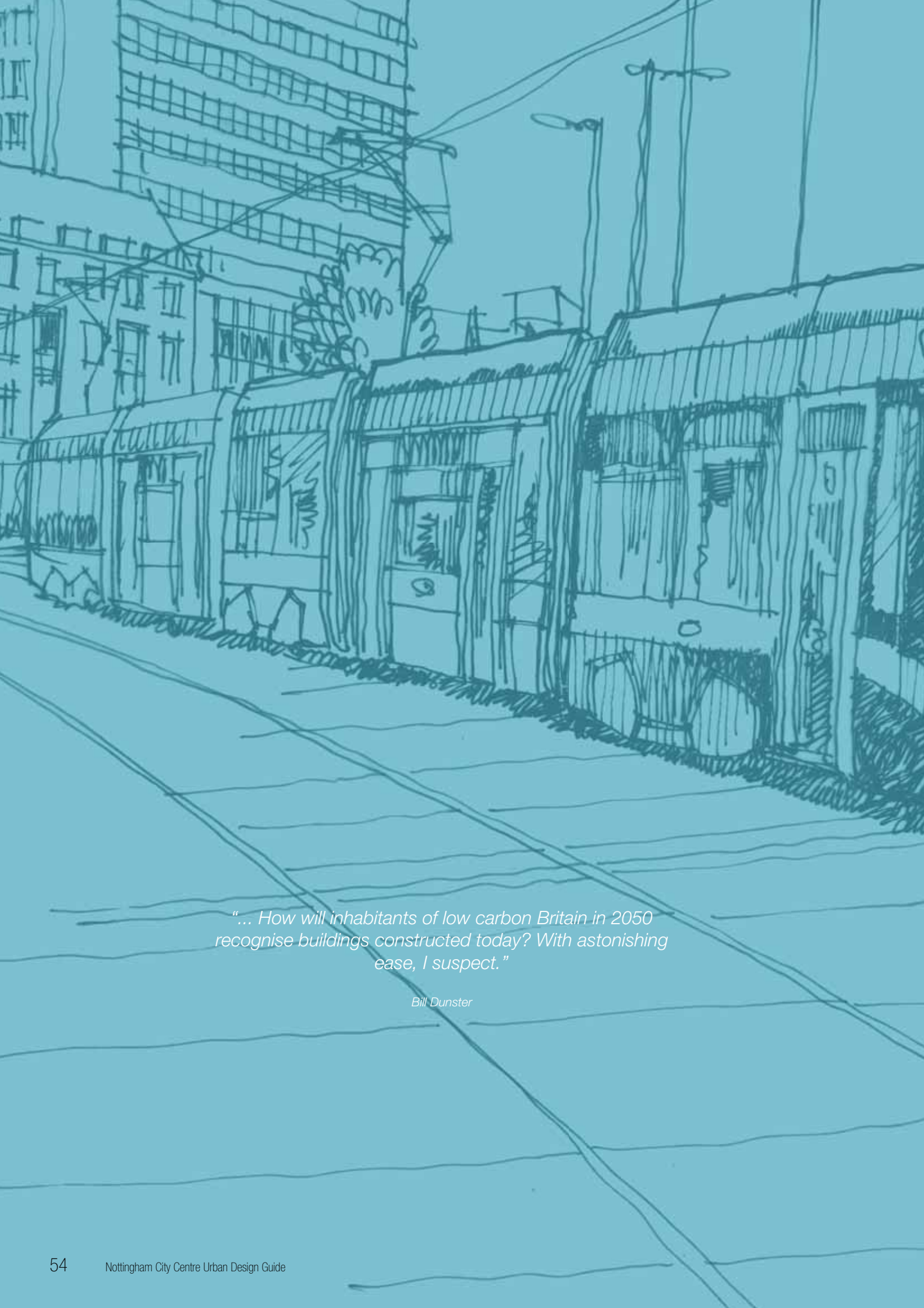

*"... How will inhabitants of low carbon Britain in 2050 recognise buildings constructed today? With astonishing ease, I suspect."*

*Bill Dunster*





# Sustainability

## Introduction

Nottingham has led the way in establishing clear policies and guidance on sustainable development, and by providing leadership on climate change. It has also seen the development of a number of leading edge sustainable buildings. This urban design guide seeks to set out how, through good urban design, the fabric of the city can become more environmentally sustainable and how, in turn, it can support more sustainable lifestyles.

New development creates a significant opportunity to raise standards, and to ensure that the urban fabric of Nottingham responds to the challenges of a world in which climate change and high energy prices are increasingly a reality. Adapting and responding to this changing world will mean challenges, but will also produce opportunities to create a modern city which is more attractive and sustainable in the long term.



### Sky View Factor

This plan shows how much sky is visible from each street in Nottingham. On the positive side more sky equals more light and sun, and less need for artificial lighting and heating. On the negative side it can increase exposure to Winter wind chill and Summer overheating. The black lines indicate the case study areas used on p58.

Sky View	Equivalent enclosure ratio
Red	Highest 0.8 = Open Space or Roof Space
Orange	0.7 = 1:2
Yellow	0.6 = 1:1.75
Light Green	0.5 = 1:1.5
Green	0.4 = 1:1.25
Light Blue	0.3 = 1:1
Blue	0.2 = 1:0.75
Dark Blue	Lowest 0.1 = 1:0.5



# Sustainability

## Today

**Historically sustainability has only played a limited role in shaping Nottingham's urban form. From the medieval streets and industrial buildings of the Lace Market to the recent influence of modernism, the urban fabric has responded to the economic needs of a growing city.**

The older areas of the city centre have a tighter urban grain. Whilst the narrow streets provide shelter from prevailing winds and a feeling of intimacy they tend to reduce natural daylight and passive solar gain. Traditionally this was overcome by incorporating lightwells and courtyards into buildings to provide ventilation and natural daylight.

More recent buildings have forgotten some of the lessons of the past. Modernism brought larger and deeper plan buildings that are difficult to keep warm in winter and cool in summer. They also tend to require more artificial lighting and energy intensive comfort cooling for occupants. Modern apartments have tended to be built with only a single-aspect and with large areas of heat loss from glazing.

The tightening up of Building Regulations and the introduction of the Code for Sustainable Homes will mean that buildings in the future will need to be built to higher standards. Nottingham has some notable examples of how buildings can respond to this challenge. These include Michael Hopkins' Inland Revenue Building and recent Jubilee Campus, and Marsh Grochowski's Lacemakers House.

Sustainable design does not just benefit the environment. Research has shown that early consideration of sustainable urban design creates healthier and more attractive places

to live and work. Nottingham would benefit from places and buildings that are designed with a sustainable future in mind.

**The contribution of urban form:** Urban design has a vital role to play in ensuring that buildings benefit from natural daylight, warmth and ventilation. Cambridge University Architectural Research have analysed Nottingham against two important sustainable urban design concepts:

■ **Sky View Factor (SVF):** How much of the sky is visible from the street. A low SVF creates a feeling of density and enclosure and a sheltered microclimate, but reduces natural daylighting and solar gain so increasing energy usage. The plan to the left analyses SVF in Nottingham. The blue areas indicate the areas with the lowest sky view. These include the narrow streets of the historic city and the areas of taller buildings.

■ **Passive Zones:** The proportion of a building's floor area that can be naturally daylighted, heated or ventilated. Deep plan buildings with low ceilings require artificial lighting, heating and cooling, significantly increasing their energy use. The plans on the following page analyse the passive building zones in different parts of Nottingham, showing how the historic core works far better than the larger buildings in the northern part of the city centre.

In addition to these issues we have also looked at the role of 'green infrastructure' – trees, vegetation and water - in the public realm and its potential to provide natural shading and air conditioning, and to control run-off through Sustainable Urban Drainage (SUDs).



Inland Revenue Building  
© Martine Hamilton Knight



Jubilee Campus  
© Martine Hamilton Knight



Lacemakers House  
© Marsh Grochowski Architects

## Passive Zones and Shading

Four case studies have been studied in detail by the Martin Centre at Cambridge University as shown on the plan on p56. These show the passive zones of each building type. This is the area of building within 6m of an external wall that can be lit and ventilated naturally.



### COARSE GRAIN LEISURE AND EDUCATIONAL USES:

In the larger buildings to the north of the city centre almost half of the floor area (44.3%) is outside the passive zone. The buildings are tall but widely spaced so that the sky view factor is good and the level of shading low, but this could increase Summer cooling demand and Winter wind chill.



### FINE GRAIN RETAIL / FOOD AREAS:

In the retail heart of the city the buildings are smaller and the proportion of passive floor area rises to 74.9%. The narrow streets do however create more shading which might make this location more appropriate for office uses.



### RESIDENTIAL / MIXED-USE:

The residential areas to the west of the city combine a high level of passive floor area (74.3%) with high sky view factor and low shading. Residential uses may be more appropriate in this area than the more compact Lace Market area, if they are arranged around open spaces and courtyards in order to benefit from solar gain.



### THE LACE MARKET:

The buildings of the Lace Market, built as they were so that lace workers had natural light, have the highest level of passive floor area (85.3%). The tall buildings and narrow streets do, however, reduce the sky view factor and increase shading. With larger areas of glazing and atriums, residential uses might be suitable although commercial uses may be more appropriate.

# Sustainability

## Strategy

**Nottingham's urban form needs to be designed to reduce the energy use of its buildings for heating, cooling and lighting. It also needs to create an attractive city, promoting walking and cycling, where people can live at higher densities without using their car and which meets people's need for green spaces.**

Nottingham will need to develop, adapt and future-proof the urban fabric of the city. The amount of floor space that can be naturally lit and ventilated should be maximised. Whilst higher densities are desirable, enclosure ratios should not overly restrict daylighting and solar gain. Proposals for tall buildings will also need to ensure that their potential benefits are not outweighed by additional energy and resource use.

The narrower streets of the older parts of the city centre can create problems with shadows and sky view. However, the buildings are punctuated by lightwells and courtyards allowing light to penetrate, often into the rear of buildings. The scale of the buildings also means that most of the internal space is in the passive zone, within 6m of windows.

New buildings in these areas should respect the historic character, the width of the streets and the height of the buildings while maximising daylight to the new accommodation. Care will need to be taken in the design

and massing of buildings, for example by using setbacks and courtyards, to ensure that new residential buildings in particular have adequate daylight and do not overshadow existing buildings and public spaces.

In parts of the city centre where there are larger buildings, such as those along Maid Marian Way, there are good sky views. However, the height and bulk of the buildings can create problems of shadowing and the floor plates are often too deep to be naturally ventilated and lit. Exposed facades can also lead to overheating if they are not shaded. In these areas new buildings should be designed as more slender structures and the appropriate orientation and shading for different uses considered. Larger atriums and courtyards should be glazed in order to minimise heat losses.

In areas that are being masterplanned there is an opportunity to optimise energy use and sustainability. In these areas residential space should be dual aspect where possible and located to maximise its south-facing aspect – for example around public spaces or by facing onto wider streets or courtyards. Workspace should be located in more shaded northerly orientations to reduce the potential for overheating whilst still benefiting from daylighting.

Higher density accommodation and narrower streets should be offset with generous and green courtyards and public areas of open space to create attractive liveable neighbourhoods. Ideally these open spaces should be oriented north/south to get the sun at lunchtime and later in the day. All masterplans should be tested for overshadowing and wind to ensure that they do not create adverse micro-climate effects.



The Lace Market is designed to maximise natural lighting



Broad sunny streets like Forman Street attract street cafes



Narrow streets like Kings Walk are more shaded

# Sustainability

## Rules

**5.1 Enclosure and sky view:** Buildings should be designed to avoid excessive overshadowing and to allow natural lighting and passive solar heating, particularly for residential accommodation. On narrow streets, with enclosure ratios above 1:1.5 (see glossary for a definition) shading is likely to be a problem on the lower floors of buildings. New residential streets should therefore not exceed this enclosure ratio. Where this is unavoidable, as in the core of the city centre, measures to address the problem could include locating offices or retail space on lower floors, increasing glazing or ensuring that flats have a second aspect on an internal courtyard that exceeds this enclosure ratio.

*Justification: Enclosure ratios and the proportion of sky view have a strong influence on the amount of daylight and solar radiation received by buildings. The need to create urban streets should be balanced with the potential for passive heating and lighting. Offices require less direct sunlight.*

**5.2 Passive zones:** The plan depth of commercial buildings should be no more than 12m for single-height spaces with windows on both sides. For single aspect space or where the building fronts onto streets with an enclosure ratio narrower than 1:0.5, floor plates should be no deeper than 8m.

*Justification: Deep-plan office buildings require mechanical ventilation and artificial lighting. A building's passive zone is the portion of its floor area that can realistically be naturally lit and ventilated.*

**5.3 Residential accommodation:** Where possible residential properties should have two aspects. Single-aspect apartments will not be permitted facing within 30° of due north or onto streets with less than a 1:1.5 enclosure ratio. Where single-aspect flats are proposed, the depth of the flat should not exceed 6m and an atrium should be created to provide natural light to the central corridor.

*Justification: Single aspect flats receive less sunlight and solar radiation, particularly with unfavourable orientations. Internal corridors require constant electric lighting, pushing up communal energy use.*

**5.4 Glazing ratios:** Glazing ratios should be varied depending on the orientation of the elevation. North facing elevations should include 30% glazing. Other facades should have 50% glazing to maximise daylighting. Higher glazing ratios will need to be compensated for by higher U-Values (rate of heat flow) particularly on northern elevations.

*Justification: Glazing is important for daylighting but windows have ten times greater heat loss than well insulated walls. The glazing ratio is the proportion of glazed area to wall area and excludes frames and mullions.*

**5.5 Massing and overshadowing:** Building massing should avoid overshadowing. Provided that they do not overshadow adjacent sites, larger blocks should be placed towards the northern side of streets and squares. Changes in levels should be used to improve solar penetration to streets and south facing facades. Shadow studies should be included in Design and Access Statements.

*Justification: Abrupt changes in building heights can blight adjacent buildings reducing solar gain and daylighting.*

**5.6 Renewable energy:** Nottingham's planning policy requires all larger schemes (major applications) for new buildings to reduce their CO<sub>2</sub> emissions by using existing and future renewable energy technologies. The accommodation of solar collectors and photovoltaic panels on new and refurbished buildings is encouraged. Only listed buildings are likely to be subject to restrictions. All new buildings should be future-proofed to allow the installation of solar technology.

*Justification: Most buildings should be capable of accommodating renewable energy. Solar is seen as more appropriate and effective in Nottingham city centre than wind technology. Buildings could also be connected to low carbon energy networks.*

**5.7 Cooling and Glare:** Buildings should be designed to avoid glare and enable natural cooling without the need for air conditioning. The design of facades should allow for through ventilation and sunshading. Green roofs and deciduous trees are effective in providing cooling and shading.

*Justification: Poor design can lead to overheating and glare in office space and atria. This increases energy use through air conditioning and artificial lighting when blinds have to be closed.*

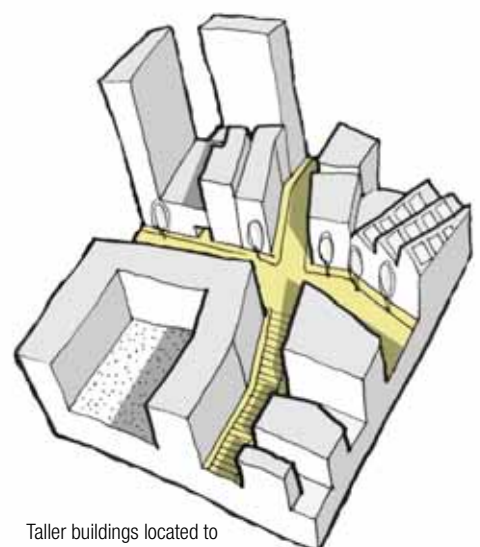

Taller buildings located to the north of the site reduce overshadowing.



Nottingham Express Transit (NET) in Old Market Square

**5.8 Microclimate effects:** All large schemes should be modelled for microclimate effects to avoid downdrafts from tall buildings, wind tunnelling and excessive shading. This is particularly important in streets and spaces where street cafes are planned.

*Justification: Tall buildings and poorly designed spaces create a microclimate that makes public areas unpleasant to use, reduce the success of planting and causes street cafes to use energy-intensive lighting and space heaters.*

**5.9 Tall buildings:** Tall buildings should be subject to stricter carbon emission requirements than current Building Regulations. Their energy performance should be modelled to take into account the increased exposure and potential for overheating at greater heights. A minimum reduction of 25% over the Building Regulation's Target Emissions Rate (TER) should be achieved. Glazing ratios should be no more than 50% and solar gain should be controlled. This should be fully described in the Energy Statement to accompany the application.

*Justification: Buildings with a height of more than 15 storeys are less sustainable because they suffer from increased exposure, require more materials with a greater embodied energy to construct and additional energy to operate lifts and pumping equipment for water and heating. Very high glazing ratios increase the extent of heat loss and the risk of overheating.*

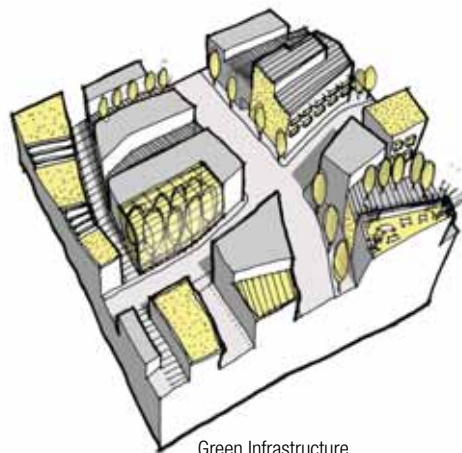

Green Infrastructure

**5.10 Materials:** Building materials should be of low embodied energy and, where possible, manufactured from resources available on a sustainable basis in the region.

*Justification: In order to reduce its ecological footprint Nottingham will encourage the greater use of resources and building materials available in the East Midland's region.*

**5.11 Recycling:** Multi-material recycling systems should be integrated into all new development in a way that is convenient, inconspicuous and efficient to use and with reference to the Council's Planning Guidance for 'New Developments Waste Storage and Collection 2008'.

*Justification: In order to increase recycling rates a wider range of multi-material recycling services will need to be provided to businesses and households.*

**5.12 Green infrastructure:** Streets, public spaces, courtyards, facades and roofs should incorporate natural greenspace to maximise biodiversity. At least 30% of the site area should be greenspace on the completed scheme (including green roofs). There should be 8 street trees per 100 metre of street outside the core of the city centre. The choice of species should be based on native flora and habitats selected to survive in urban areas.

*Justification: Vegetation and greenspace improves the quality of the urban environment as recognised in the Growth Point subregional 'green infrastructure' strategy. It can moderate extremes of temperature and microclimate, and meet people's intrinsic needs for a natural environment.*

**5.13 Drainage:** Larger schemes should incorporate Sustainable Urban Drainage Systems (SUDS) and all schemes should use permeable surfacing, landscaping and green or brown roofs to reduce surface water run-off.

*Justification: Heavy rainfall has led to flash floods in urban areas in recent years. Reducing the rate of run-off reduces the flooding risk and sustains the watertable.*

**5.14 Cycling:** At least one secure and weather-proof cycle parking space should be provided for every new residential unit and per 100m<sup>2</sup> of office space. Cycle parking should be incorporated into new office developments as well as the public realm at convenient points. New streets and public spaces should be designed to include features that make them safe for cyclists.

*Justification: Cycling should be promoted as a safe and convenient form of transport.*



*One of the most pleasant and beautiful towns in England*

*Daniel Defoe - A Tour through the  
whole island of Great Britain 1724-7*



# Design

## Introduction

The guide so far has concerned itself with the good manners of urban design. The rules on urban form, massing, activity, sustainability and public realm will help a city that works, that is easy and pleasant to use, that is safe and supports a range of businesses and is a good place to live. The rules will not however create the spark that makes somewhere really special, that exceptional building that people love, the serendipity of design and space that makes Nottingham what it is.

All these things are impossible to write rules for; they depend on the imagination of designers and the farsightedness of their clients. The design guide can however create the conditions where quality design is encouraged and where flair and creativity can flourish. The final section of the guide therefore analyses the character of the city centre today before setting out a strategy for promoting design quality and defining conditions to help this happen.





ARBORETUM

CANNING CIRCUS

WELLINGTON CIRCUS

THE PARK

CASTLE

CANAL

OLD MARKET SQUARE

LACE MARKET

SNEINTON MARKET

STATION

**Built Heritage**

- Listed Buildings
- Conservation Areas

# Design

## Today

**Part of the debate about the development of this Urban Design Guide has focused on the issue of 'Nottinghamness', the unique character of the city that sets it apart from other places. This however is very hard to pin down because part of what makes Nottingham special is the eclectic collection of building styles that make up the city centre.**

As we described in the section on the history of Nottingham, the city grew in a different way to other large cities. Cities like Liverpool, Bristol and Newcastle expanded outwards creating Georgian neighbourhoods at a time when the growth of Nottingham was constrained by the common fields that surrounded the historic city. Later the explosive growth of cities like Manchester and Leeds saw large parts of their centres knocked down and redeveloped by the Victorians. Nottingham did not do this, instead it added layer upon layer of development onto its medieval core. Whereas the great Victorian cities have an architectural unity from the period of their growth, Nottingham is an eclectic collection of styles from the last thousand years of its history. In this respect it has more in common with historic cities like York or Chester than its fellow core cities.

This layering of history is reflected in the density of listed buildings in the city centre as indicated on the plan to the left as well as the amount of the city centre covered by conservation areas. This includes the medieval core of the city comprising the Old Market Square and its environs and the Lace Market, the Castle and the neighbourhoods on the western fringe of the city centre, the more industrial character of the station and canal to the south and the historic edge of Sneinton Market to the east.

However while these areas have a coherent urban character they are far from having a unified architectural style. The city centre includes buildings from most eras of Nottingham's history. The grain of development is generally fine so that the centre is a collection of a large number of small buildings, each of a different character and scale. The city's character comes from the way that the developer of these buildings sought to draw attention to themselves with decoration. Many of the buildings demonstrate their local origins in the materials and craftsmanship of their construction and are good examples of buildings of their time. It is important that the design strategy for Nottingham allows this to continue by ensuring that new buildings are also of their time and add to the diversity and delight of the city centre.



Nottingham Contemporary by Caruso St. John Architects ©



The Pod, Fletcher Gate by Benson Forsyth Architects



Experian Landmark House by Shepherd Robson Architects



# Design

## Strategy

**One of the problems of design guides is that they cannot easily accommodate exceptional buildings. All cities have special buildings such as churches, town halls, libraries and theatres and one of the reasons that they are special is that they don't follow the rules. It is important in this design guide to allow the freedom to develop these special buildings. A distinction is therefore made in this guide between foreground and background buildings.**

Background buildings make up the majority of buildings in the city and will be subject to the rules in this design guide. The role of these buildings is to form a backdrop to the public spaces of the city to enclose space and to generate activity. The first responsibility of these buildings is to follow the good manners of development set out in this guide and to respect the character of their context, particularly in conservation areas. Many of the most beautiful cities in the world are made up of such background buildings that are of themselves nothing special. This is not to say that we should not strive to ensure that all buildings and structures including bridges are well designed. However too often architects use design as an excuse for ignoring the fundamentals of urban design.

Background buildings are less risky on small infill sites in the city centre. Even when a small building does not work well, it is such a small part of the overall street scene that it does not do too much damage. The problems happen with major developments because if they go wrong they can have a huge negative impact. This is where efforts need to be focused. The planning authority will expect to be involved in these larger schemes at a very early stage and will expect to agree a design brief for the site. Outside conservation areas the outline planning process will be used to establish a strong framework for larger developments and developers are encouraged to use a range of architects on these larger schemes. In this way schemes should be broken up into a series of individual buildings in keeping with the character of the city.

Foreground buildings are different. In order to create iconic buildings it is necessary to have a certain freedom from the rules of building lines and active frontages etc. It is therefore proposed that certain buildings should be exempt from these rules provided that this is agreed in advance with the planning authority. This agreement should take place before the design process has commenced and the planning authority should have the opportunity to be involved in the process. Agreement to this process will only be forthcoming where there is a strong brief for the site, the building is commissioned by architectural competition, or where it includes an element of public use.



Long Row



Inland Revenue HQ

# Design

## Rules



Inland Revenue HQ - © Martine Hamilton Knight

**6.1 Foreground Buildings:** Certain buildings can be exempt from the rules in this guide provided that this is agreed in advance with the planning authority and the scheme is procured through architectural competition and is designed to the highest standards. In such cases the buildings will need to be positively reviewed by CABE, East Midlands Design Panel or Nottingham Design Review Panel.

*Justification: A relaxation of the rules is justified in order to create something extraordinary. However this should not be used as an excuse by developers to ignore the provisions of this guide and will only be used in exceptional circumstances with a design of international importance.*

**6.2 Masterplans:** On all significant sites developers will be expected to commission a masterplan to illustrate how the scheme will be brought forward and be integrated with its surroundings. On sites over 1ha this plan should include a design strategy to indicate how the development will be brought forward with a number of architects to create a grain and diversity in keeping with the character of the city.

*Justification: Large schemes have the greatest potential to go wrong and there is a tendency for architects and their clients to treat them as large pieces of architecture that are out of keeping with the character of Nottingham.*



Bottle Lane

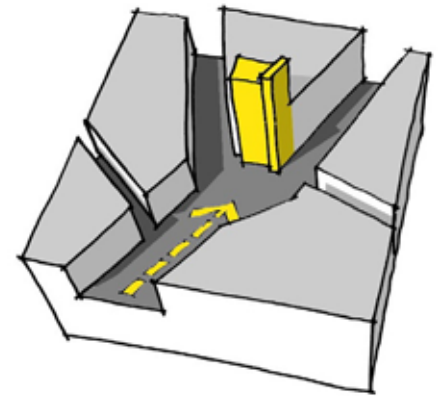

**6.3 Landmarks:** Buildings that terminate prominent views should be marked as landmarks in order to create a strong sense of place.

*Justification: The character of urban areas is enhanced by local landmarks that mark important views.*

**6.4 Contemporary design:** New buildings in the city should be of contemporary design. Buildings should be of their time, rather than being a pastiche of historic building styles.

*Justification: The character of Nottingham comprises a wide variety of buildings from different eras. Contemporary buildings should continue this tradition.*

**6.5 Respect for context:** Within the Zone of Repair (See Page 14) buildings will be expected to respect the building line, massing and grain of the city centre, face onto the public realm and create an active frontage as set out in previous sections. Buildings within conservation areas will be expected to respect the character of the conservation area but this should not prevent contemporary design solutions.

*Justification: Buildings will fit into the historic core of the city not by imitating the design of the surrounding buildings but by respecting the grain and scale of the context.*

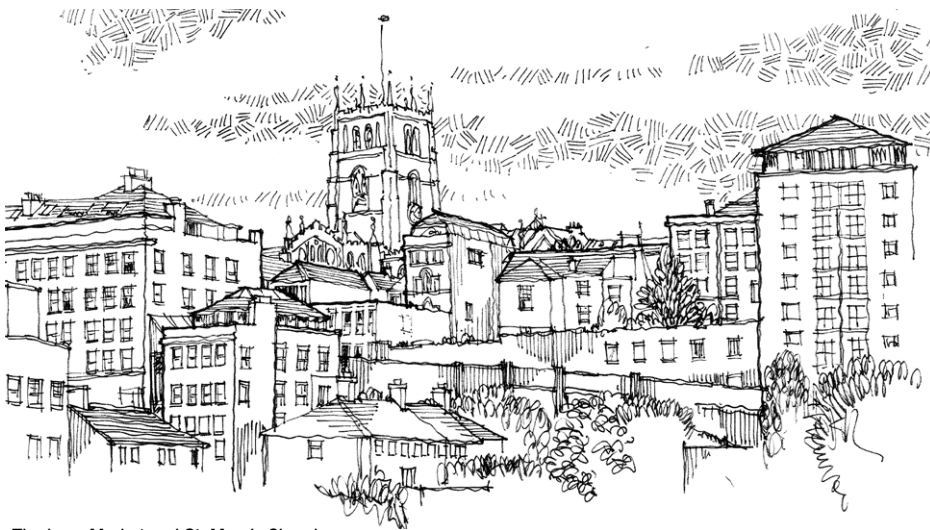

The Lace Market and St. Mary's Church

**6.6 Building good manners:** There are elements of a building's design that are independent of architectural style that architects in the city centre should respect. These include a vertical emphasis to the façade and fenestration, a tripartite structure to the building with an active ground floor, middle and top, the articulation of the elevation to provide interest and the emphasis of prominent corners and entrances.

*Justification: These elements are common to most successful buildings in an urban context such as Nottingham.*

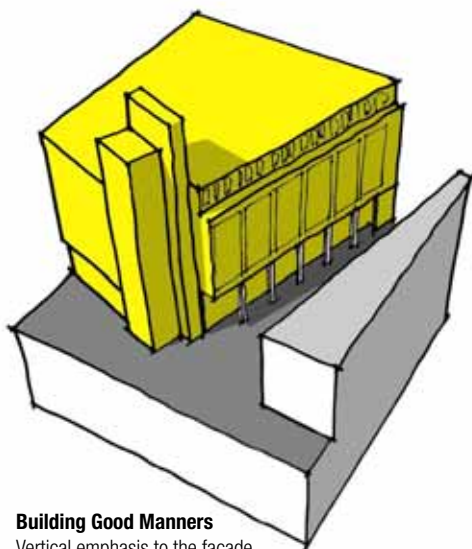

**Building Good Manners**

Vertical emphasis to the facade  
Tripartite structure  
Emphasise corners

**6.7 Quality Materials:** This guidance does not specify a palette of materials to be used in the city centre because historically Nottingham buildings have used a very wide range of materials. In the recent past there has been an overuse of cladding and some timber panelling has not weathered well. However materials should be chosen for their durability and robustness. All material must be carefully specified and detailed to add to the quality and richness of the urban scene both now and in the future when they are weathered.

*Justification: Nottingham is a city built with a wide variety of materials the common factor being quality and durability.*

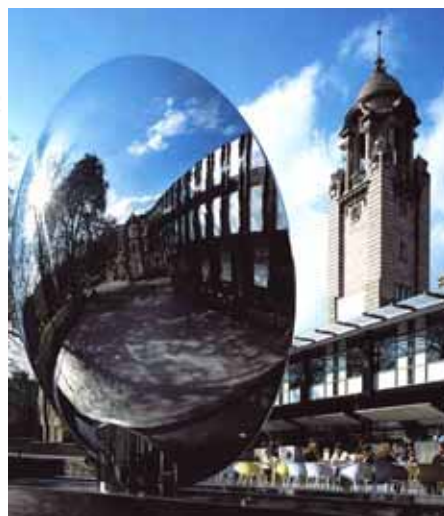

Anish Kapoor's Sky Mirror © Martine Hamilton Knight

**6.8 Public art:** All buildings should include an element of public art. Larger projects will be expected to appoint public art consultants and to include within the Design and Access Statements accompanying their planning applications a statement on public art. Designers are encouraged to integrate the work of artists into the design of buildings and the public realm. There is a tradition in Nottingham of applied art and decoration integrated into the fabric of the buildings and developers are encouraged to develop contemporary interpretations of this.

*Justification: Public art is an important way of creating a sense of place. The integration of art into the design and fabric of buildings is part of Nottingham's character.*

**6.9 Design and Access Statements:** All planning applications in the city centre will need to be accompanied by a Design and Access statement in line with Government guidelines. These will include a visual analysis of the site context as well as a justification and explanation of the design of the building and artist's impressions or computer generated images of the completed building in context. For buildings in conservation areas the Design and Access Statements should include an appraisal of the conservation area and the impact of the proposal on this character. For tall buildings verified Computer Generated Images (CGIs) will be required so that the impact of the building can be fully assessed.

*Justification: Good new buildings should respond to their context and this needs to be demonstrated in the planning application. Too often in the past, Design and Access Statements have been post-rationalisations of the scheme. It is important for the architect to explain the design intent of the building and to show that it fits into its context.*

# Glossary

**Access Points:** These are the main entry and exits between the inside of a building and the outside world. In other words: where is the front door and where is the back door? how do you get in and out of the building?

**Active Frontage:** This relates to the ground floor of buildings where they front onto a street. An active frontage is one that makes the street feel more lively and inviting such as shop windows, cafes, restaurants, showrooms, services and offices with large windows.

**Arcades:** Arcades have been used to open up the centre of urban blocks for shopping since the first Galleria were built in Milan. These are normally streets with a glazed roof like the Exchange Arcade behind the Council House. Modern malls and shopping centres are an extension of this concept and are increasingly being designed like modern arcades.

**Background Buildings:** This guide makes a distinction between foreground and background buildings. Background buildings make up the vast majority of buildings in the city centre. These are the buildings subject to the rules set out in this guide.

**Building line:** The primary front face of buildings along a street. Where all of the buildings share a common building line (which can be curved) there is continuous enclosure along the street.

**Conservation Areas:** Areas of special architectural or historic interest designated by the council in order to protect and enhance their appearance. Within these areas the council has extra controls over demolition, minor developments and work to trees. This means that conservation area consent as well as planning consent is required for new development involving demolition.

**Densities:** This relates to the intensity of development. Residential densities are normally measured as the number of units or bedspaces per hectare.

**Design and Access Statements:** Since August 2006 all planning applications have had to be accompanied by a Design and Access Statement that explains the design rationale behind the scheme development. Guidance on producing these statements are available from CABE.

**Enclosure ratio:** This is a measure of the profile of the street. It relates the height of the buildings to the width of the street (expressed in this guide with the height of the building first). In a street with a 1:1 enclosure ratio (such as Lister Gate), the height of the buildings is the same as the width of the street. If the enclosure ratio is 1:2 (for example Mansfield Road), the height of the buildings is half the width of the street. An enclosure ratio of 1:0.5 (for example Kings Walk), means that the buildings are twice as high as the width of the street.

**Eyes on the street:** This term refers to there being windows overlooking streets to make them feel supervised and safe. This is best when the windows are from residential or office accommodation.

**Fifth Elevation:** Most buildings have up to four elevations – referring to the main faces or facades of the building. The fifth elevation refers to the roof and is important where key views look down onto the structure, for example from Nottingham Castle.

**Figure Ground Plan:** This is a plan widely used by urban designers that shows buildings in black and takes away all other detail. It is useful to show the density of development, the extent to which urban space is enclosed and the grain of development.

**Footprint:** This refers to the shape of the building where it touches the ground.

**Foreground Buildings:** The design guide provides for special buildings that can be exempt from its rules. These will tend to be public buildings, of the highest architectural quality and will need to be agreed in advance by the planning authority.

**Glazing Ratios:** This refers to the amount of a façade that is glazed. It relates only to the glazed areas, not to window frames or mullions and the ratio is the proportion of this glazed area to the total internal wall area.

**Green Infrastructure:** Green infrastructure is defined by Natural England as a network of protected sites, nature reserves, green spaces and greenways that provides for habitats, wildlife, recreational and cultural experiences, flood protection and microclimate control.

**Massing:** This is a general term that refers to the three-dimensional impact of buildings.

**Masterplanning:** A masterplan is generally required for larger sites and should create a framework in which development can come forward over a number of years. The masterplan should fix the position and massing of buildings together with streets and access arrangements.



**Passive Zones:** The proportion of a building's floor area that can be naturally lit, heated or ventilated. This is usually about twice the floor-to-ceiling height so that for a typical office building it will extend around 6m into a building from the windows.

**Pedestrian Priority:** This describes a street where traffic is allowed but is subservient to pedestrians who have right of way.

**Permeability:** This refers to the ease with which people can move around an urban area. A permeable urban area has plenty of streets and it is possible to move through the area by a variety of routes.

**Plot Coverage:** The proportion of a site covered by a building.

**Predominant Building Height:** This is the height of the building as experienced from the street. It is measured from the ground to the eaves of the building and excludes roofs and plant provided that they are not visually dominant.

**Privacy Distance:** The distance between the habitable windows of a dwelling necessary to ensure privacy. This is normally 20m but is often reduced to 15m in city centres. Where a dwelling has two aspects the privacy distance relates to the elevation with the main living spaces.

**Public Realm:** All external space to which the public have access including parks, streets and squares.

**Sky View Factor:** The amount of sky that is visible from the street. A low sky view factor creates a feeling of density and enclosure but reduces natural daylighting and solar gain.

**Street Frontage:** The element of a site that faces the street. The extent to which streets are enclosed by buildings is measured in the percentage of the frontage that is enclosed. A 60% street frontage ratio would mean that 60% of the site's frontage is filled by buildings.

**Street Grid:** This relates to the entire network of streets in the city centre. The shape and character of this grid is one of the most important factors giving form to the city centre.

**Street Character:** The street grid is made up of different types of streets, some of which are more important than others. This creates a hierarchy of streets and runs from high streets to minor streets.

**Street Wall:** The walls to a street as made up of buildings addressing that street. The street wall follows the building line and the completeness of the street wall depends on the extent to which the street frontages are filled by buildings.

**Tall Buildings:** There are many definitions of tall buildings. For the purposes of this guide they are defined as any building that rises above the heights set out in the massing section for each part of the city centre. Buildings up to four storeys above these heights may be acceptable throughout the city centre in appropriate locations. Beyond this tall buildings will only be acceptable within the tall building zones.

**Tripartite Structure:** This relates to the three tiers of buildings, the base that relates to the street, the top and the central section.

**Urban Blocks:** These are the areas between the streets in the street grid. An urban block will normally be occupied by a number of individual buildings.

**Urban Fabric:** A general term referring to all of the buildings of a city and the extent to which they relate to the public realm.

**Urban Grain:** This refers to the diversity and intricacy of the urban fabric. Fine-grained urban areas are made up of a large number of small buildings often of different designs and dating from different periods for example around the Old Market Square. Coarse-grained urban areas are made up of fewer larger buildings often all of a similar design or dating from the same era such as around Maid Marian Way.

Developers will be expected to use the 3D computer model of Nottingham city centre commissioned from Zmapping, to illustrate and assess the impact of their developments on the key views and vistas.

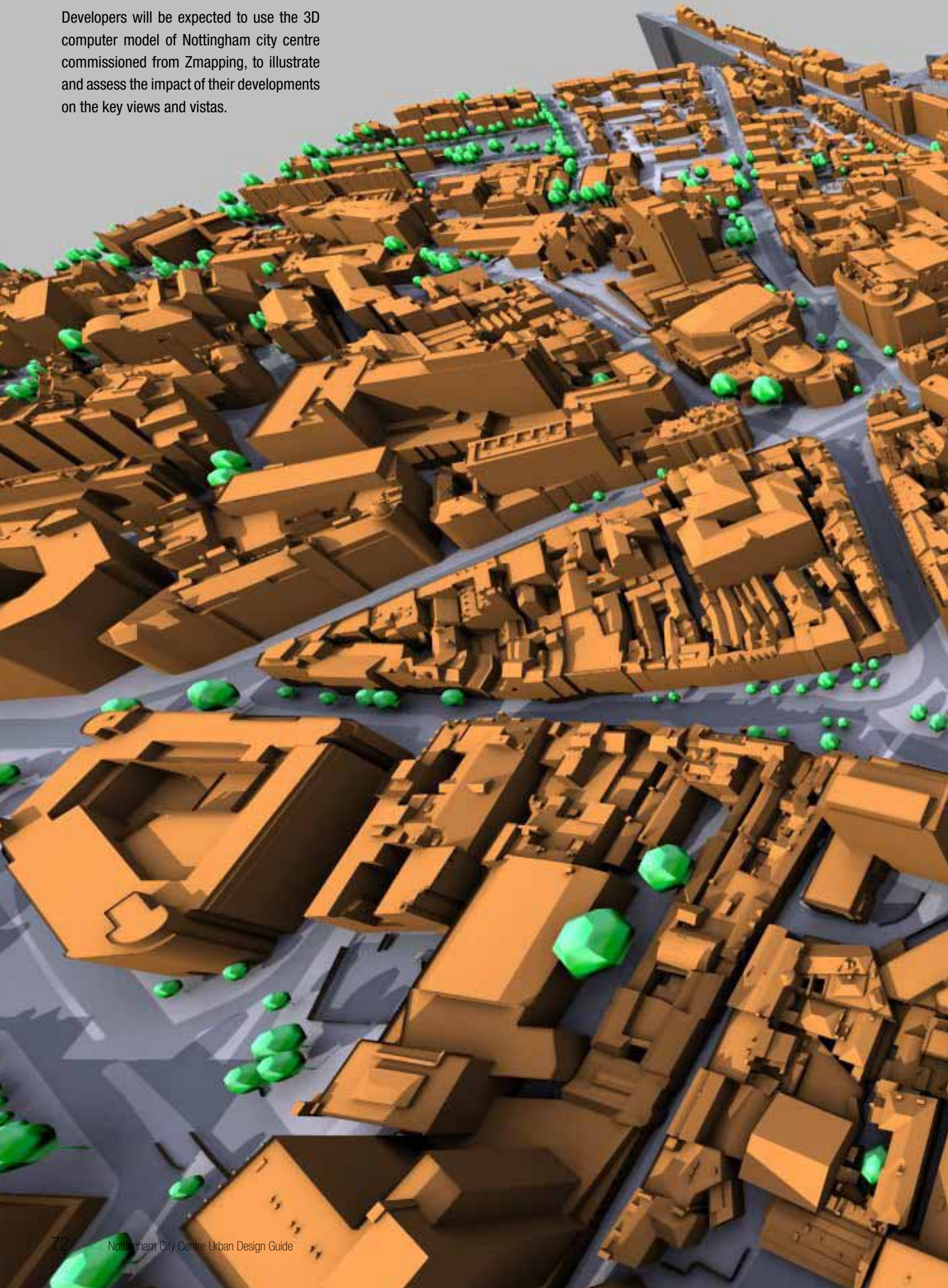



# Picture Credits

Aerial photography images are the property of Webb Aviation

OS data or OS derived data:

© Crown copyright. All rights reserved. Nottingham City Council 100019317. 2009

Aerial Data:

Copyright Geoperspectives 2009

Height/ Contour Data:

This map is reproduced from © Intermap Technologies Inc. All rights reserved. DNOT350. 2009

Photographs:

Front Cover Photograph: Sky Mirror by Anish Kapoor photographed by **Hannah Marsh**

Back Cover Photograph: Old Market Square at Night photographed by **Debbie Whitmore, Nottingham Trent University**

Photographs are credited on page

All other photographs are taken and owned by **URBED**

# Contact

City Centre and Urban Design Team: **0115 9155479**

Email: [nigel.turpin@nottinghamcity.gov.uk](mailto:nigel.turpin@nottinghamcity.gov.uk)

Website: [www.nottinghamcity.gov.uk](http://www.nottinghamcity.gov.uk)

This Urban Design Guide has been produced for Nottingham City Council and Nottingham Regeneration Ltd. by URBED.

May 2009

URBED  
10 Little Lever Street  
Manchester  
M1 1HR  
[info@urbed.coop](mailto:info@urbed.coop)  
[www.urbed.coop](http://www.urbed.coop)  
t. 0161 200 5500



**Nottingham**  
**City Council**



